

# Service Manual

74 DD-92/01G/02G/05G/07G

74 DD-82/01B/02B/05B/07B

Digital compact cassette recorder

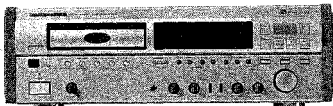

## TABLE OF CONTENTS

TECHNICAL SPECIFICATIONS	2
CONNECTIONS AND CONTROLS	3
SERVICE HINTS	4
DISASSEMBLY	5
SERVICE MODES / FACTORY MODES	5
MICROPROCESSOR I/O PINS AND THEIR FUNCTIONS	8
BLOCK DIAGRAM	10
DESCRIPTION OF SIGNAL NAMES	12
VOLTAGE CHARTS	19
WIRING DIAGRAM	25
SCHEMATIC DIAGRAM AND PARTS LOCATIONS	26
MAIN PCB (PG03) / POWER SUPPLY PCB (PP63) / DC SUPPLY PCB (PS03) /	
POWER TRANSFORMER TERMINAL PCB (PP63)	28
POWER SUPPLY CIRCUIT (PP03) / POWER TRANSFORMER TERMINAL CIRCUIT (PP63) /	
POWER CIRCUIT (PG03-1/6) / DC SUPPLY CIRCUIT (PS03)	32
$\mu$ -COM CIRCUIT (PG03-2/6)	35
MECHA CIRCUIT (PG03-3/6)	38
ANALOG IN, DIGITAL IN/OUT CIRCUIT (PG03-4/6) / REC/BALANCE VOLUME CIRCUIT (PV03)	41
REC/BALANCE VOLUME PCB (PV03)	43
DOLBY, MUTE, ANALOG OUT CIRCUIT (PG03-5/6)	44
HEADPHONE, QMS CIRCUIT (PG03-6/6) / HEADPHONE CIRCUIT (PH03-1/2) / (PH03-2/2)	47
HEADPHONE PCB (PH03)	49
DIGITAL CIRCUIT (PZ03-1/2)	50
DIGITAL CIRCUIT (PZ03-2/2)	53
DIGITAL PCB A/B SIDE (PZ03)	56
READ/WRITE PCB A SIDE (PW03)	60
READ AMP CIRCUIT (PW03-1/2)	61
WRITE AMP CIRCUIT (PW03-2/2)	64
READ/WRITE PCB B SIDE (PW03)	66
A/D CONVERTER CIRCUIT (PA03-1/2)	67
AD/DA PCB (PA03)	70
AD/DA PCB (PA03)	71
D/A CONVERTER CIRCUIT (PA03-2/2)	72
TRAY WIRE CONNECTIVE, SERVO CIRCUIT (PM03)	75
TRAY WIRE CONNECTIVE, SERVO PCB (PM03)	76
FRONT PCB (PD03)	80
FRONT CIRCUIT (PD03)	82
HEAD, DECK MECHANISM AND THEIR INTERFACES	85
ELECTRICAL MEASUREMENTS AND ADJUSTMENT	89
SET EXPLODED VIEW AND PARTS LIST	91
DECK EXPLODED VIEW AND PARTS LIST	94
ELECTRICAL PARTS LIST	97

# marantz®

## model DD-92/DD-82

First issue : 1992

4822 725 50979

PCS 67 454

## MARANTZ DESIGN AND SERVICE

Using superior design and selected high grade components, MARANTZ company has created the ultimate in stereo sound.

Only original MARANTZ parts can insure that your MARANTZ product will continue to perform to the specifications for which it is famous.

Parts for your MARANTZ equipment are generally available to our National Marantz Subsidiary or Agent.

### ORDERING PARTS:

Parts can be ordered either by mail or by telex. In both cases, correct part number has to be specified.

The following information must be supplied to eliminate delays in processing your order:

1. Complete address
2. Complete part numbers and quantities required
3. Description of parts
4. Model number for which part is required
5. Way of shipment
6. Signature: any order form or telex must be signed otherwise such part order will be considered as null and void.

### MARANTZ INTERNATIONAL

Vestdijk 9  
5600 MD Eindhoven  
The Netherlands  
Phone: +31/40.758290  
Telefax: +31/40.75.82.99  
Telex: 35000 PHTC NL routing IND NLMTFAT

### PARTS ORDERING

Parts may be ordered or advice can be given at the following addresses:

**AUSTRIA**  
MARANTZ  
Hietzinger Kai 137a  
1130 Wien

**BELGIUM**  
MARANTZ EUROPE B.V.  
Div. Benelux  
P.O. Box 218  
Building HCM9  
5600 MD Eindhoven  
The Netherlands  
Fax: 11 01 11

**CHILE**  
MARANTZ  
DIVISION OF PHILIPS S.A.  
AV. Santa Maria, 0760  
Casilla 2687  
Santiago  
Telex: 240.239

**DENMARK**  
MARANTZ  
Horsingelø 5  
2630 Tårnby

**NORWAY**  
MARANTZ  
Postboks 7634  
Asoliden  
3007 Drammen

**FRANCE**  
MARANTZ FRANCE  
4 Rue Bonnard Palissy  
92600 Asnières  
France  
Telex: 611651

**GERMANY**  
MARANTZ GERMANY GmbH  
Alexandrastraße 1  
2000 Hamburg  
Germany

**THE NETHERLANDS**  
MARANTZ EUROPE B.V.

Div. Benelux  
P.O. Box 218  
Building HCM9  
5600 MD Eindhoven  
The Netherlands  
Fax: 040 - 75 52 86

**SWEDEN**  
MARANTZ  
Box 1324  
171 25 Solna

**FINLAND**  
MARANTZ  
Kuortaneentie 1  
00520 Helsingfors 52

**GREAT BRITAIN**  
MARANTZ HEI U.K. Ltd.  
Kingsbridge House  
Paxbury oaks  
575-583 Bath Road  
Longford  
Middlesex UB7 0EH  
Fax: 0753 680 428

**GREECE**  
SHERTON ELECTRONICS S.A.  
P.O. Box 21025  
Hippokratous Street 188  
Athens 11471  
Greece  
Telex: 216.795

**JAPAN**  
MARANTZ JAPAN, Inc.  
39-1, 7-chome, Sagami-cho  
Sagamihara-shi, Kanagawa  
Japan

**KUWAIT**  
AL ALAMIAH ELECTRONICS  
Usama Building  
Fahd al Suleim Street  
P.O. Box 20781  
Safat Kuwait  
Telex: 22694

**ITALY**  
MARANTZ ITALIANA S.P.A.  
Via Chiave, 74  
20126 Milano  
Italy

**SAUDI ARABIA**  
AL ALAMIAH ELECTRONICS  
P.O. Box 5954  
University Street  
Riyadh 11432  
Saudi Arabia  
Telex: 401530

**SOUTH AFRICA**  
MARANTZ  
DIVISION OF PHILIPS S.A.  
Main Road Marindale  
P.O. Box 58088  
Newville 21114  
South Africa

**SPAIN**  
Euroservice S.A.  
Bernardo obregón, 20  
28012 Madrid  
Fax: 3412.306.198

**SWITZERLAND**  
MARANTZ  
Technischer Service  
Duesstrasse 3  
3186 Dödingen  
Switzerland

**TURKEY**  
DOGRUOL Ltd.  
I.M.C.  
6 Blok N°6310  
Unkapani  
Istanbul  
Turkey  
Telex: 22065

**MALTA**  
CACHIA & GALEA  
Republic Street, 68D  
Valetta  
Telex: 1682

















**PORTUGAL**  
MARANTZ  
Divisao Philips S.A. service  
Ourense-carnaxide  
2795 LINDA-A-VELHA  
Telex: 43906

All of the above locations are fully equipped to take care of your total service needs. Because various countries have differing configuration requirements, it is necessary that you contact the service facility in your particular country. In the event that there is no service location listed for your country, please, contact the nearest facility for the necessary assistance.

In case of difficulties, do not hesitate to contact the Technical Department at above mentioned address.

## TECHNICAL SPECIFICATIONS

D/A Conversion	Bitstream DAC-7 Differential Mode 1 Bit Pulse Density Modulation with 20 bit 8 times oversampling digital filter	Total Harmonic Distortion Digital (playback)	<.003% at 1 kHz (DD-92) <.0035% at 1 kHz (DD-82)
A/D Conversion	Bitstream $\Sigma - \Delta$ Sigma-Delta Modulation 64 times oversampling with 18 bit resolution	Channel Separation Digital (playback)	100 dB at 1 kHz
Frequency Response:		Wow and Flutter Digital	below the limit of measurement
Digital		Analog (WRMS)	.015%
48 kHz sampling	10 Hz - 22 kHz $\pm$ 0.2 dB	Output Level and Impedance	
44.1kHz sampling	10 Hz - 20 kHz $\pm$ 0.2 dB	Analog Fixed	2 V / 1.5 k $\Omega$
32 kHz sampling	10 Hz - 14.5 kHz $\pm$ 0.2 dB	Analog Variable	0 ~ 2 V / 1.5 k $\Omega$
Analog (Type II tape)	20 Hz - 18 kHz $\pm$ 3 dB	Digital co-axial	.5 V p-p / 75 $\Omega$
		Digital optical	Toslink-19 dBm
S/N ratio (A-weighted)		Power supply	
Digital (playback)	>103 dB (DD-92) >101 dB (DD-82)	/01 version	110-120/220-240V AC 50/60 Hz
Analog (no NR, Type II)	>59 dB	/02 version	230V AC 50/60 Hz
Dolby B improvement	up to 10 dB	/05/07 version	240V AC 50/60 Hz
Dolby C improvement	up to 20 dB	U version	120V AC 60 Hz 35W
Dynamic range		Dimensions	
Digital (playback)	>100 dB	Width	456 mm, 17 7/8" (including side panels)(DD-92) 420 mm, 16 1/2" (DD-82)
		Height	132 mm, 5 3/4"
		Depth	344 mm, 15 1/4"
		Weight	13 kg, 26 lbs (DD-92) 8.2 kg, 17 lbs (DD-82)

	Carbon film 0.125 W or 0.2 W	70°C	5%		Ceramic plate Tuning $\leq$ 120 pF NP.0	2%	*a = 2.5 V b = 3.15 V or 4 V
	Carbon film 0.25 W or 0.33 W	70°C	5%		Polyester flat foil	10%	c = 6.3 V d = 10 V e = 16 V f = 25 V g = 40 V h = 63 V j = 100 V i = 125 V m = 150 V n = 180 V
	Metal film 0.25 W or 0.33 W	70°C	5%		Metalized polyester flat film	10%	q = 200 V r = 250 V s = 300 V t = 350 V u = 400 V v = 500 V w = 630 V x = 1000 V A = 1.5 V B = 6 V C = 12 V D = 15 V E = 20 V F = 35 V G = 50 V H = 75 V I = 80 V
	Carbon film 0.5 W	70°C	5%		Polyester flat foil small size (Mylar)	10%	
	Carbon film 0.67 W	70°C	5%		Polystyrene film/foil	1%	
	Carbon film 1 W or 1.15 W	70°C	5%		Tubular ceramic		
					Miniature single		
					Subminiature tantalum	$\pm$ 20%	
(C) Chip component							

# CONNECTIONS AND CONTROLS

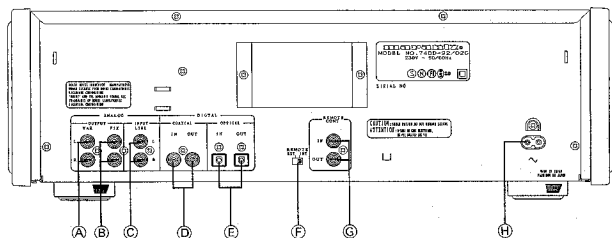
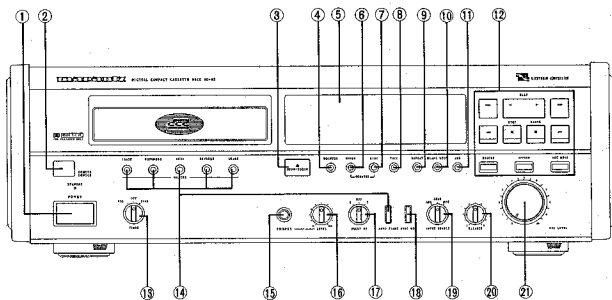

- |                                     |  |                          |          |
|-------------------------------------|--|--------------------------|----------|
| ① Power (standby) switch            | S851                                     | Ⓜ Phones                 | JH02     |
| ② Remote sensor                     | QD02                                     | Ⓝ Phones level control   | RH01     |
| ③ Open/close switch                 | SD17                                     | Ⓞ Dolby NR switch        | SD32     |
| ④ Monitor switch                    | SD25                                     | Ⓟ Sync rec switch        | SD22     |
| ⑤ Display                           | VD01                                     | Ⓠ Input select switch    | SD33     |
| ⑥ Counter reset switch              | SD19                                     | Ⓡ Rec balance control    | RV02     |
| ⑦ Time switch                       | SD21                                     | Ⓢ Rec level control      | RV01     |
| ⑧ Text switch                       | SD20                                     | Ⓐ Variable out           | J741     |
| ⑨ Repeat switch                     | SD01                                     | Ⓑ Fixed out              | J740     |
| ⑩ Blank skip switch                 | SD27                                     | Ⓒ Line in                | J742     |
| ⑪ AMS switch                        | SD26                                     | Ⓓ Digital coaxial in/out | JA03     |
| ⑫ Recording/playback control switch | SD03-06, 08, 09,<br>SD15, 16, 24, 28, 29 | Ⓔ Optical in/out         | JA01, 02 |
| ⑬ Timer play/off/rec switch         | SD31                                     | Ⓣ Remote ext/int switch  | SR01     |
| ⑭ Marker control switch             | SD10-14, 23                              | Ⓤ Remote cont. d-bus     | JR01     |
|                                     |  | Ⓚ Main socket            | J093     |

## SERVICE HINTS

### GB WARNING

All ICs and many other semi-conductors are susceptible to electrostatic discharges (ESD). Careless handling during repair can reduce life drastically.

When repairing, make sure that you are connected with the same potential as the mass of the set via a wrist wrap with resistance. Keep components and tools also at this potential.

### F ATTENTION

Tous les IC et beaucoup d'autres semi-conducteurs sont sensibles aux décharges statiques (ESD).

Leur longévité pourrait être considérablement écourtée par le fait qu'aucune précaution n'est prise à leur manipulation. Lors de réparations, s'assurer de bien être relié au même potentiel que la masse de l'appareil et enfilez le bracelet sert d'une résistance de sécurité.

Veiller à ce que les composants ainsi que les outils que l'on utilise soient également à ce potentiel.

### D WARNUNG

Alle ICs und viele andere Halbleiter sind empfindlich gegen elektrostatische Entladungen (ESD).

Unvorsichtige Behandlung bei der Reparatur kann die Lebensdauer drastisch vermindern. Sorgen Sie dafür, dass Sie im Reparaturfall über ein Polkabelband mit Widerstand mit dem Massepotential des Gerätes verbunden sind, halten Sie Bauteile und Hilfsmittel ebenfalls auf diesem Potential.

### ESD



### NL WAARSCHUWING

Alle IC's en vele andere halfgeleiders zijn gevoelig voor electrostatische ontladingen (ESD).

Onzorgvuldig behandelen tijdens reparatie kan de levensduur drastisch doen verminderen. Zorg ervoor dat u tijdens reparatie via een polsband met weerstand verbonden bent met hetzelfde potentiaal als de massa van het apparaat.

Houd componenten en hulpmiddelen ook op ditzelfde potentiaal.

### I AVVERTIMENTO

Tutti IC e parecchi semi-conduttori sono sensibili alle scariche statiche (ESD).

La loro longevità potrebbe essere fortemente ridotta in caso di non osservazione della più grande cauzione alla loro manipolazione. Durante le riparazioni occorre quindi essere collegato allo stesso potenziale che quello della massa dell'apparecchio tramite un bracciale a resistenza.

Assicurarsi che i componenti e anche gli utensili con quali si lavora siano anche a questo potenziale.

## HANDLING CHIP COMPONENTS

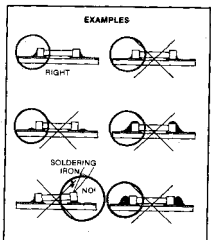
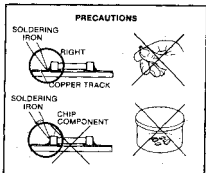
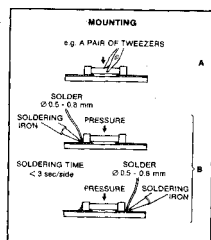
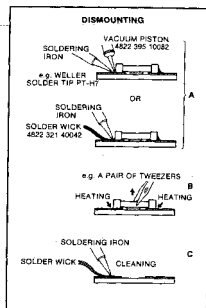
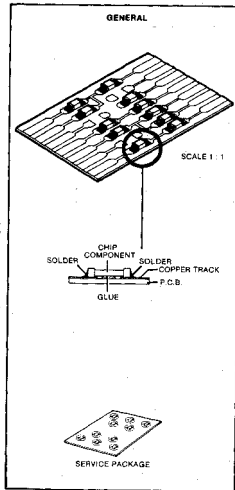

## DISASSEMBLY

### REMOVING THE TOP COVER

DD-92 Remove the 6 caps (A) ~ (F) and remove the 8 screws ① ~ ⑧.

DD-82 Remove the 8 screws ① ~ ⑧.

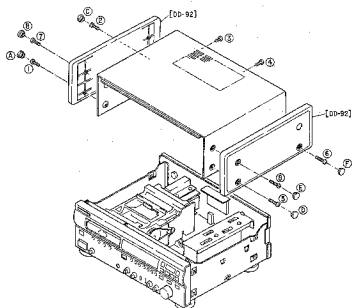

### REMOVING THE CASSETTE COVER

- 1) Push the OPEN/CLOSE button ① and open the tray.
- 2) To unlock the tray panel, press the ② and ③ of the rocking knobs as shown in arrow direction.
- 3) Remove the tray panel ④ drawing it as shown in arrow direction.

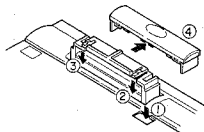

### REMOVING THE FRONT PANEL

- 1) Remove the tray panel (cassette cover).
- 2) Remove the 5 screws ① ~ ⑤.

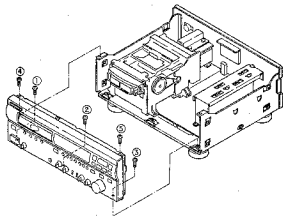

### REMOVING THE LOADER (TRAY MECHANISM)

Remove the 4 screws ① ~ ④.

### REMOVING THE DECK MECHANISM

- 1) Remove the 4 screws ① ~ ④.
- 2) Remove the 4 screws ⑤ ~ ⑧.

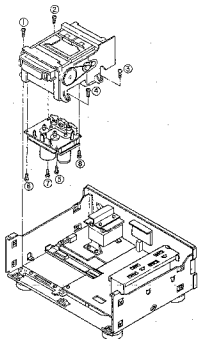

### REMOVING THE POWER SUPPLY P.C.B.

Remove the 5 screw ① ~ ⑤ and remove the spacer ⑥.

### REMOVING THE MAIN P.C.B.

Remove the 12 screws ⑦ ~ ⑱ and remove the spacer ⑰.

### REMOVING THE DIGITAL P.C.B. AND AD/DA P.C.B.

Draw out each P.C.B. as shown in arrow direction. (⑲ ~ ⑳)

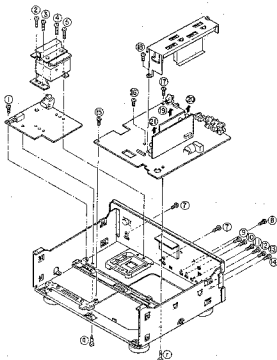

## SERVICE MODE

### 1. START service mode :

Press PLAY (▶) key and STOP (■) key together and then POWER-ON.

### 2. Functions available (select with TIME key) :

- 0 scrolling list of available display characters  
(This performs as soon as turning POWER-ON.)
- 1 all display elements on
- 2 all display elements off one by one
- 3 display eye channel on oscilloscope  
(select channel by using remote controls 0...8)  
TIME key : SET EYE CH   
STOP mode : GO PLAY MODE  
PLAY mode : EYE CH NO,   
4 display system error rate for chosen channel  
TIME key : SYS ERR RATE  
STOP mode : GO PLAY MODE  
PLAY mode : ERR SYS   
5 display aux error rate  
TIME key : AUX ERR RATE  
STOP mode : GO PLAY MODE  
PLAY mode : ERR AUX   
6 display main error rate  
TIME key : MAIN DATA   
STOP mode : GO PLAY MODE  
PLAY mode : MAIN CH   
7 display all error rate average  
TIME key : ALL ERR RATE  
STOP mode : GO PLAY MODE  
PLAY mode : SA 0 1 2 3 4 5 6 7  
immediately PLAY MODE :   
changed each 0 ~ F
- 8 display all error rate real time  
TIME key : ALL ERR DISP  
STOP mode : GO PLAY MODE  
PLAY mode :   
It is OK, if the display is stable between 0 and 2.
- 9 back to function 0  
STOP mode : 0 PLAY MODE

Displayed information is directly coming from DEQ and DDSP.

However, the test 3 is not available on this model.

### 3. END :

Press COUNTER RESET key.

## FACTORY MODE

### START Factory mode :

Press STOP (■) key and BACKWARD (◀) key together and then POWER-ON.

1. All of display elements on after several seconds of DISPLAY : **FACTORY** MODE, and "PLAY", "REC" and "STAND BY" LEDES lights.

### 2. Press TIME key once.

- 2-1. The modes on TIMER SW are displayed.

PLAY mode :  TIMER PLAY  
OFF mode :  TIMER OFF  
REC mode :  TIMER REC

↑  
The numerals in paragraph 2-2 are displayed.

- 2-2. Make sure the length of DCC cassette, and SW (SW mechanism).

Display	LENGTH Run time of cassette tape			REC SW (Protect)	TIME min.
	0	1	2		
0	OFF	OFF	OFF	OFF (REC is able.)	45
1	ON	OFF	OFF		60
2	OFF	ON	OFF		75
3	ON	ON	OFF		90
4	OFF	OFF	ON		105
5	ON	OFF	ON	ON (Protect (REC is inable.)	120
6	ON	ON	ON		
7	ON	ON	ON		* 1
8	OFF	OFF	OFF		* 2
9	ON	OFF	OFF		45
A	OFF	ON	OFF		60
B	ON	ON	OFF		75
C	OFF	OFF	ON		90
D	ON	OFF	ON	105	
E	ON	ON	ON	120	
F	ON	ON	ON		

SWITCH side : TAPE side \*1 When no cassette is installed.

OFF (Open) : With hole

ON (Closed) : without hole \*2 When music tape is installed.

- 2-3. When each MARKER key is pressed, display is changed to numeral mode.

When each MARKER key is pressed, numeral display is changed.

AUTO key : 1 TIMER   
WRITE key : 2 TIMER   
RENUMBER key : 3 TIMER   
NEXT key : 4 TIMER   
REV key : 5 TIMER   
ERASE key : 6 TIMER   
Refer to paragraph 2-1 for the display.

3. Press TIME key once.

- 3-1. In this case, Ageing mode (Also OK in Analog compact cassette)

DISPLAY :  AGEING   
when a cassette is installed.

▶ PLAY → STOP → FF (▶▶) → REW (◀◀) → OPEN → CLOSE

Approx. 90 sec.

4. Press TIME key once.

- 4-1. In this case, Direct REC (Just press REC key, then recording starts).

If REW (◀◀) key is pressed while recording, recording stops after rewinding until start position of the record, (The marker when stopping to record is not written.)

5. Press TIME key once.

Back to 1.

END :

MICROPROCESSOR I/O PINS AND THEIR FUNCTIONS

QD01:  $\mu$ PD75P238

Pin No.	Port Name	I/O	Act	Function	Pin No.	Port Name	I/O	Act	Function		
1	AND	MODEL SELECT	I	H	Model name sensor	48	VDD	VDD	--	VDD, +5V	
2	AVREF	AVREF	--	--	AD converter reference voltage, +5V	49	VEE	--	--	-5V	
3	AVDD	AVDD	--	--	AD converter power supply, +5V	50	VEE	--	--	-5V	
4	VDD	VDD	--	--	VDD, +5V	51	VEE	--	--	-5V	
5	VDD	VDD	--	--	VDD, +5V	52	TRAY	TRAY CLOSE	O	H	Tray open output
6	X2	X2	--	--	Main clock, 4.19MHz	53	TRAY	TRAY OPEN	O	H	Tray close output
7	X1	X1	--	--	Main clock, 4.19MHz	54	P71	VOL. DOWN	O	H	Motor volume up
8	IC	--	--	--	GND	55	P70	VOL. UP	O	H	Motor volume down
9	XT2	--	--	--	N. C.	57	PE3	--	--	N. C.	
10	XT1	--	--	--	GND	58	PE2	ACK	IO	L	Communication with Mecha $\mu$ -com
11	Vss	Vss	--	--	Vss, GND	59	PE1	REDFY	I	L	Communication with Mecha $\mu$ -com
12	S16	S16	O	H	Segment output	60	START	START	IO	N	Communication with Mecha $\mu$ -com
13	S17	S17	O	H	Segment output	61	PS3	KEY 7	I	H	Key input
14	S18	S18	O	H	Segment output	62	PS2	KEY 6	I	H	Key input
15	S19	S19	O	H	Segment output	63	PS1	KEY 5	I	H	Key input
16	S20	S20	O	H	Segment output	64	PS0	KEY 4	I	H	Key input
17	S21	S21	O	H	Segment output	65	Vss	Vss	--	--	Vss, GND
18	S22	S22	O	H	Segment output	68	PI3	KEY 3	I	H	Key input
19	S23	S23	O	H	Segment output	67	PA2	KEY 2	I	H	Key input
20	S0	S0	O	H	Segment output *Key scan output in common	68	PA1	KEY 1	I	H	Key input
21	S1	S1	O	H	Segment output *Key scan output in common	69	PA0	KEY 0	I	H	Key input
22	S2	S2	O	H	Segment output *Key scan output in common	70	P33	DIS OFF	O	H	Display OFF output
23	S3	S3	O	H	Segment output *Key scan output in common	71	P32	STAND BY LED	O	L	Stand by LED lights
24	S4	S4	O	H	Segment output	72	PE1	REC LED	O	L	REC LED lights
25	S5	S5	O	H	Segment output	73	P30	PLAY LED	O	L	PLAY LED lights
26	S8	S8	O	H	Segment output	74	PE3	--	--	--	N. C.
27	S7	S7	O	H	Segment output	75	PE2	RC-5 OUT	--	--	N. C.
28	S9	S9	O	H	Segment output	76	P21	RC-5 MASK	I	L	Remote control input inhibit
29	S8	S8	O	H	Segment output	77	P20	EASY LINK OUT	O	L	Easy Link output
30	S9	S9	O	H	Segment output	78	PI3	CD EDIT	--	--	CD edit
31	VDD	VDD	--	--	VDD, +5V	79	PI2	--	--	--	N. C.
31	VLOAD	VLOAD	--	--	+30V power supply for display	80	PI1	EASY LINK SELECT	I	--	Easy Link/RC-5 input selection High: RC-5, Low: EASY
32	T15	T15	O	H	Digit output	81	PI0	REMOTE IN	I	L	Remote control input
33	T14	T14	O	H	Digit output	82	S0	SI	I	L	Communication data input with mecha $\mu$ -com
35	T12	T12	O	H	Digit output	83	S00	SD	O	L	Communication data output with mecha $\mu$ -com
36	T11	T11	O	H	Digit output	84	SC00	SCK	I	L	Communication clock with mecha $\mu$ -com
37	T10	T10	O	H	Digit output	85	P00	--	--	--	GND
38	T9	T9	O	H	Digit output	86	RESET	RESET	I	L	Reset
39	T8	T8	O	H	Digit output	87	AVss	AVss	--	--	AD converter Vss, GND
40	T7	T7	O	H	Digit output	88	AN7	--	--	--	GND
41	T6	T6	O	H	Digit output	89	AN6	TRAY SW	I	H	Tray position sensor
42	T5	T5	O	H	Digit output	90	AN5	TIMER SW	I	H	Timer/Rec/Time/PLAY sensor
43	T4	T4	O	H	Digit output	91	AN4	DOLBY SW	I	H	Dolby OFF/PG sensor
44	T3	T3	O	H	Digit output	92	AN3	SELECTOR	I	H	Optical/Coaxial/Analog input sensor
45	T2	T2	O	H	Digit output	93	AN2	LEVEL METER (R)	I	H	Level meter input, Rich
46	T1	T1	O	H	Digit output	94	AN1	LEVEL METER (L)	I	H	Level meter input, Lch
47	T0	T0	O	H	Digit output						

QU01:  $\mu$ PD75P518

Pin No.	Port Name	I/O	ACT	Function	Pin No.	Port Name	I/O	ACT	Function		
1	AND	OMS	I	H	Blank sensor input	41	P50	ACK	IO	L	Communication with Front $\mu$ -com
2	AVREF	AVREF	--	--	AD converter reference voltage, +5V	42	P53	START	O	L	Communication with Front $\mu$ -com
3	AVDD	AVDD	--	--	VDD, +5V	43	PE2	REDFY	IO	H	Communication with Front $\mu$ -com
4	VDD	VDD	--	--	VDD, +5V	44	P51	DIS PRT	O	L	Communication with Front $\mu$ -com
5	PI13	LTEN SBC	O	H	SBC enable output	45	P20	SD IN/OUT	O	L	Communication with Front $\mu$ -com
6	PI12	LTEN DSP	O	H	EDSP enable output	46	T0	AUX ENV	I	P	AUX label sensor
7	PI11	LTEN DAJ	O	H	DAJ enable output	47	INT 2	START SEG	I	L	Interface sync signal
8	PI10	LTEN EQU	O	H	DEQ enable output	48	INT 1	PROU	I	H	U bit data information indicator input
9	PI02	LT CONT 0	O	H	IC mode control	49	INT 0	T-REEL	I	P	Take-up reel pulse
10	PI02	LT CONT 1	O	H	IC mode control	50	SIO	LT DATA IN	I	L	LT interface data input
11	PI01	CS	O	H	EP PROM chip select	51	S00	LT DATA OUT	O	L	LT interface data output
12	PI00	U SYNC I	O	L	U bit data, indicator output	52	SC00	LT CLOCK	O	L	LT interface data clock
13	P58	DATA IN	I	P	EP PROM data input	53	INT 4	S-REEL	I	P	Supply reel pulse
14	P92	--	--	--	Pull down	54	Vss	Vss	--	--	Vss, GND
15	P91	IM START	I	L	U bit data, message start input	55	XT1	XT1	--	--	GND
16	P90	U SYNC O	I	L	U bit data, indicator input	56	XT2	XT2	--	--	N. C.
17	P88	--	--	--	GND	57	IC	--	--	--	GND
18	PE2	--	--	--	N. C.	58	X1	X1	--	--	Main clock, 4.19MHz
19	PE1	--	--	--	N. C.	59	X2	X2	--	--	Main clock, 4.19MHz
20	P80	PWM CAP	--	--	N. C.	60	RESET	RESET	I	L	Reset
21	P73	BRK SOL 2	O	L	Brake solenoid drive, Low	61	P143	DOLBY C	O	L	Dolby IC control
22	P72	BRK SOL 1	O	L	Brake solenoid drive, High	62	P142	DOLBY OFF	O	L	Dolby IC control
23	P71	TRG SOL	O	L	Trigger solenoid drive	63	P141	P-BREC	O	--	Rec/Play output Low: Rec, High: Play
24	P70	CAP MOTOR	O	L	Capstan motor drive	64	P140	DCO/ACC	O	--	DCO/ACC output High: DCC, Low: ACC
25	PE3	PWM	--	--	N. C.	65	P139	LINE MUTE	O	H	Line mute output
26	PE2	SPEED	O	--	Reel motor control Low: High speed, High: Low speed	66	P132	4BK	O	H	Line out gain control
27	PE1	REV	O	H	Reel motor control, Reverse	67	P131	44K	O	H	Line out gain control
28	P60	PWD	O	H	Reel motor control, Forward	68	P130	DE-EMPHASIS	O	H	Emphasis ON output
29	PE0	POWER DOWN	I	L	Mecha reset when Power is OFF	69	P128	TAPE IN	I	--	Tape loaded/unloaded sensor Low: loaded, High: unloaded
30	PE2	LABEL	I	H	Label sensor	70	P122	DCO/ACC IN	I	--	ACC/DCO Tape sensor Low: ACC, High: DCC
31	PE1	VERGIN	I	H	Virgin tape sensor	71	P121	LEADER	I	H	Quick sensor detection
32	PE0	--	--	--	GND	72	P120	MODE SW	I	--	Head base position sensor High: Stop, Low: Play
33	Vss	Vss	--	--	Vss, GND	73	AVss	A Vss	--	--	AD converter Vss, GND
34	P43	RESET	O	L	Reset for IC	74	AN7	REC PROTECT	I	--	Rec sensor/inhibited Low: inhibited, High: enable
35	PA2	READ ON/OFF	O	--	READ AMP ON/OFF High: ON, Low: OFF	75	AN6	TAPE LENGTH 0	I	--	DCC tape length sensor Detects the length with 5-pin ON/OFF matrix
36	PA1	--	--	--	N. C.	76	AN5	TAPE LENGTH 1	I	--	
37	PA0	--	--	--	N. C.	77	AN4	TAPE LENGTH 2	I	--	
38	P39	--	--	--	N. C.	78	AN3	DEBUG 0	--	--	Pull up
39	P32	SET SW	--	--	N. C.	79	AN2	DEBUG 1	--	--	Pull up
40	P31	ATT DAC	--	--	N. C.	80	AN1	DEBUG 2	--	--	Pull up



## HEAD, DECK MECHANISM AND THEIR INTERFACES

### DCC head

Heads used in the DCC are called a thin film head and made by repeating 20 times or more of multiple evaporations and splatterings as in fabricating ICs.

Accordingly, the heads have different features and characteristics from those of coil winding type heads used in conventional Analog cassette tape decks.

1. Playback head uses a magnetic resistance element (MR element).
2. The MRE needs magnetic bias to obtain its maximum output. So, a bias conductor which is equivalent to a coil to develop the magnetic bias is installed.
3. Moreover, analog playback head needs a magnetic feedback to increase linearity. This is realized by giving a magnetic field proportional to the MRE output from a bias conductor.

Terminals and structure of the DCC head are shown in the Fig. 1.

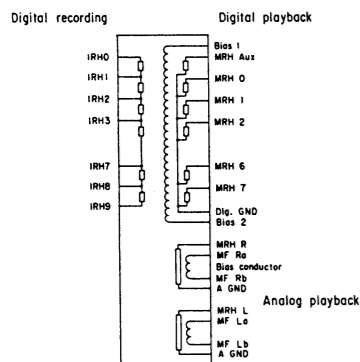

Fig. 1 DCC HEAD TERMINAL LIST AND THE STRUCTURE

### Cautions of handling of heads

The heads are susceptible to electrostatic voltage (about DC150V).

The heads are protected from external electrostatic charging by connecting the head flexible cables to the Read/Write PCB.

When disconnecting the cables, always place the deck on a bench with required electrostatic discharging measures taken and wear an electrostatic discharging band.

Moreover, always mount the short-clip on the flexible cables removed.

The heads are also susceptible to strong external magnetic field and the analog output may be affected. Do not use a head demagnetizer, etc.

### WARNING

DO NOT USE A DEMAGNETIZER CASSETTE.

### AUTOREVERSE CASSETTE DECK

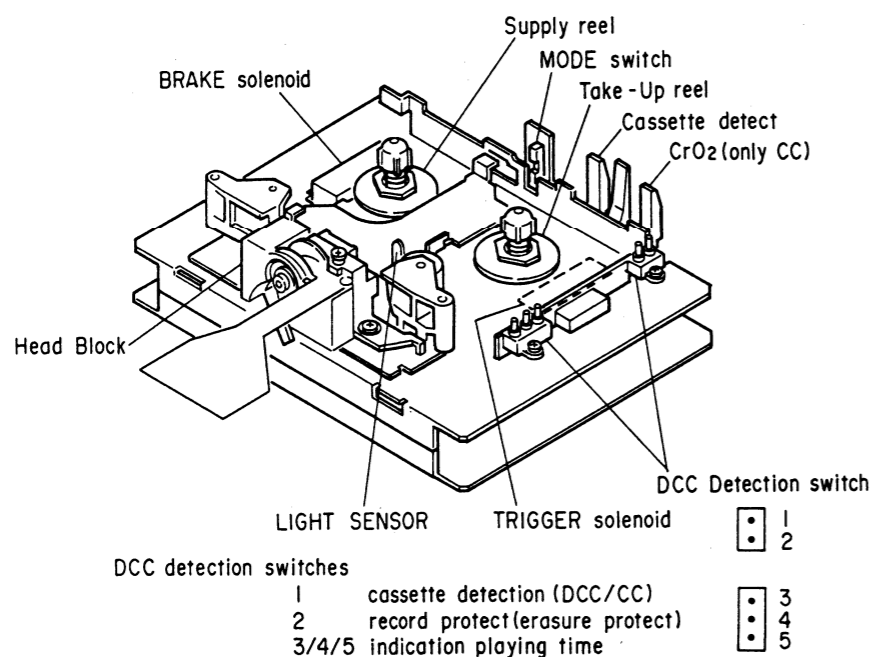

### Pairing with Read/Write PCB

For each head,

- setting for amount of bias (for both analog and digital)
- feedback adjustment (only for analog playback)

are required.

That is, a pairing is needed for heads and R/W PCB to which the heads are connected. So, when the R/W PCB is replaced or the head is replaced, potentiometers (trimming resistors) on the R/R/ PCB must be readjusted.

The adjustment requires dedicated adjustment jigs.

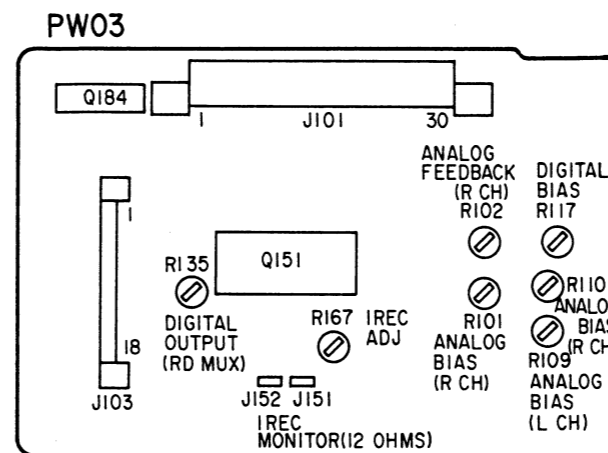

Fig. 2

### Read/Write PCB adjustment

As previously stated, a pairing adjustment has been made for specified heads and the R/W PCB in the factory in preceding the shipment. So, following adjustments are not necessary in service stations PCB a first time.

(Perform replacement of deck, heads, R/W PCB and tray loader as one unit.)

### Adjustment with dedicated jigs in the factory

1. Analog playback head bias adjustment (R109:Lch, R110:Rch)
2. Analog playback head feedback adjustment (R101:Lch, R102:Rch)
3. Digital playback head bias adjustment (R117)
4. Digital playback head playback output level adjustment (R135)
5. Digital record head record current adjustment (R167)

1. and 2. determine distortion value in the analog playback.

2. determines frequency response in the same way. Accordingly, tampering the trimming resistors for 1. and 2. will deteriorate those characteristics. These operations can be monitored at Ana L and R terminals on the R/W/ PCB.

3. will be replaced with a fixed resistor in near future. Since the digital output has only two values 1 or 0, minor waveform distortion can be accepted.

4. is the adjustment for an attenuator to develop a specified voltage for sending a signal to the signal process circuit (DCC PCB). This can be used to test a correct output is obtained from the head. This operation can be monitored at RMUX terminal on the R/W PCB.

5. is required to record signals in a constant depth on a tape.

For each head, a recommended record current exists individually. (140 ~ 180mA) If this value is not adjusted correctly, the RD MUX value in 4 does not match between a self recorded tape and prerecorded tape. Moreover, if a recording is made at a deep layer with a high value, the previous records can not be erased when an overwrite recording is made at that area later, and error rate will be increased at that area.

### Check points for R/W PCB

Under normal operations, the following signals can be observed out of R/W PCB connectors.

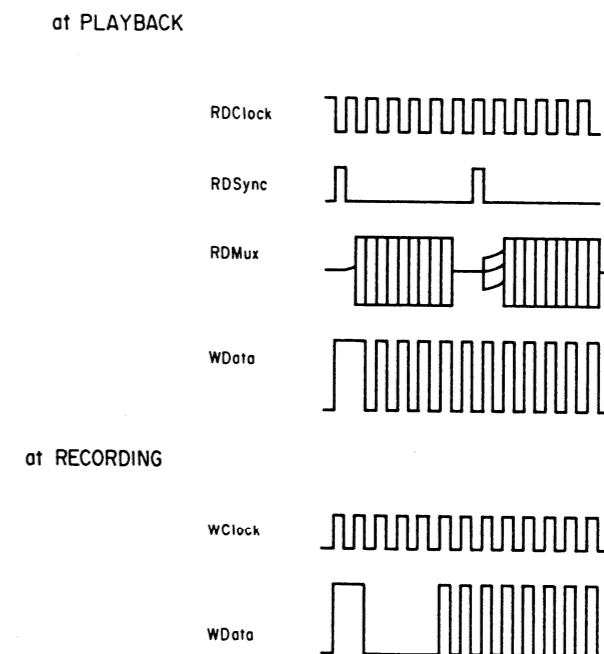

Fig. 3

The actual waveforms are shown photo 1 to 2.

### Pairing with Read/Write PCB

For each head,

- setting for amount of bias (for both analog and digital)
- feedback adjustment (only for analog playback)

are required.

That is, a pairing is needed for heads and R/W PCB to which the heads are connected. So, when the R/W PCB is replaced or the head is replaced, potentiometers (trimming resistors) on the R/R/ PCB must be readjusted.

The adjustment requires dedicated adjustment jigs.

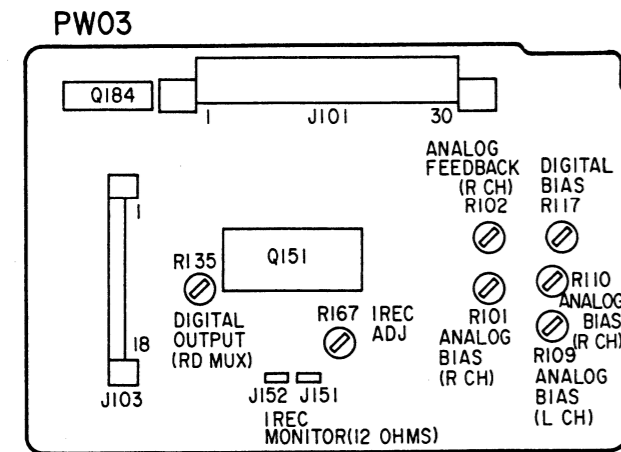

Fig. 2

### Read/Write PCB adjustment

As previously stated, a pairing adjustment has been made for specified heads and the R/W PCB in the factory in preceding the shipment. So, following adjustments are not necessary in service stations PCB a first time.

(Perform replacement of deck, heads, R/W PCB and tray loader as one unit.)

### Adjustment with dedicated jigs in the factory

1. Analog playback head bias adjustment (R109:Lch, R110:Rch)
2. Analog playback head feedback adjustment (R101:Lch, R102:Rch)
3. Digital playback head bias adjustment (R117)
4. Digital playback head playback output level adjustment (R135)
5. Digital record head record current adjustment (R167)

1. and 2. determine distortion value in the analog playback.

2. determines frequency response in the same way. Accordingly, tampering the trimming resistors for 1. and 2. will deteriorate those characteristics. These operations can be monitored at Ana L and R terminals on the R/W/ PCB.

3. will be replaced with a fixed resistor in near future. Since the digital output has only two values 1 or 0, minor waveform distortion can be accepted.

4. is the adjustment for an attenuator to develop a specified voltage for sending a signal to the signal process circuit (DCC PCB). This can be used to test a correct output is obtained from the head. This operation can be monitored at RMUX terminal on the R/W PCB.

5. is required to record signals in a constant depth on a tape.

For each head, a recommended record current exists individually. (140 ~ 180mA) If this value is not adjusted correctly, the RD MUX value in 4 does not match between a self recorded tape and prerecorded tape.

Moreover, if a recording is made at a deep layer with a high value, the previous records can not be erased when an overwrite recording is made at that area later, and error rate will be increased at that area.

### Check points for R/W PCB

Under normal operations, the following signals can be observed out of R/W PCB connectors.

at PLAYBACK

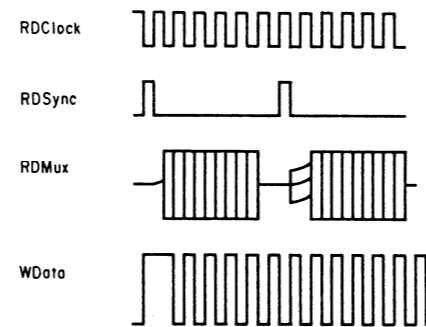

at RECORDING

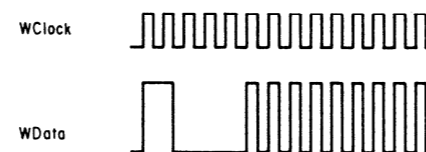
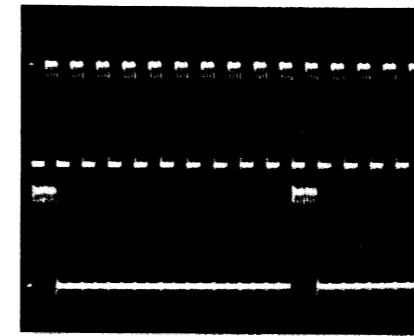

Fig. 3

The actual waveforms are shown photo 1 to 2.

At PLAYBACK

Photo 1



Up: Rdclock  
Dn: Rdsync  
X : 0.5μS/div  
Y : 0.2V/div

At RECORDING

Photo 2

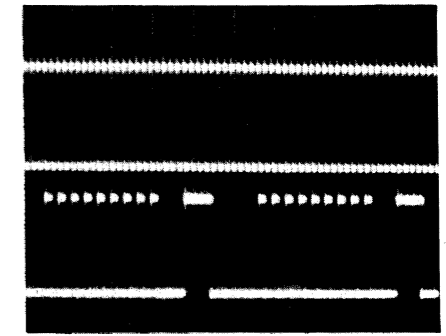

Up: Wclock  
Dn: Wdata  
X : 2μS/div  
Y : 0.2V/div

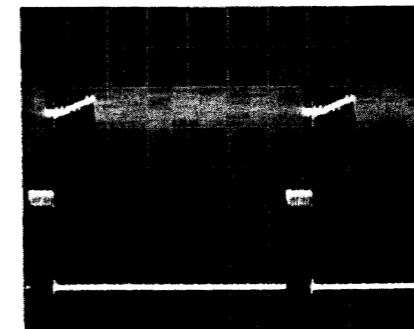

Up: Rdclock  
Dn: Rdsync  
X : 0.5μS/div  
Y : 50mV/div(Up)  
Y : 0.2V/div(Dn)

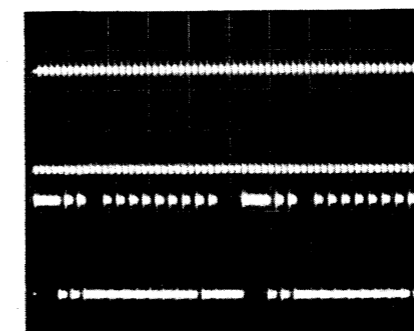

Up: Wclock  
Dn: Wdata  
X : 2μS/div  
Y : 0.2V/div

At PLAYBACK

Photo 1

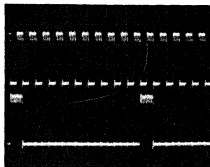

Up: Rdclock  
Dn: Rdsync  
X :  $0.5\mu\text{S}/\text{div}$   
Y :  $0.2\text{V}/\text{div}$

At RECORDING

Photo 2

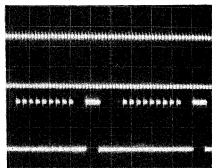

Up: Wdclock  
Dn: Wdata  
X :  $2\mu\text{S}/\text{div}$   
Y :  $0.2\text{V}/\text{div}$

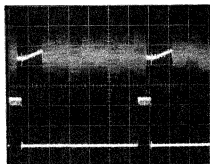

Up: Rdclock  
Dn: Rdsync  
X :  $0.5\mu\text{S}/\text{div}$   
Y :  $50\text{mV}/\text{div}(\text{Up})$   
Y :  $0.2\text{V}/\text{div}(\text{Dn})$

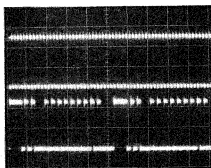

Up: Wclock  
Dn: Wdata  
X :  $2\mu\text{S}/\text{div}$   
Y :  $0.2\text{V}/\text{div}$

## DCC capstan servo

### Record:

DDSP IC on the DCC PCB continuously outputs a rectangular waveform of 24kHz, 50% duty. This can be monitored at check point on the PCB, #3 of J411. With this rectangular waveform the capstan motor rotates at a specified speed to record signals on a tape.

### DCC playback:

Digital signal from the head is read, and speed deviation is calculated and output as a variation of duty at the speed terminal. The servo circuit on the tray PCB cycle changes the output into a drive force for the capstan motor, thereby performing the control.

Since the capstan motor is of electronic governor type, it has four terminals, +, -, A, and B.

### Analog playback:

Continuously develops a fixed rectangular waveform signal of 24kHz, 50% duty as in the record mode.

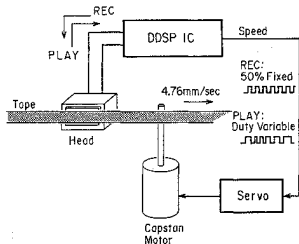

### DCC capstan servo system

The actual waveforms are shown photo 3.

## SPEED SIGNAL

## Photo 3

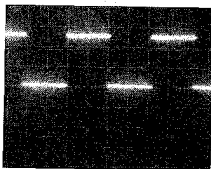

At RECORDING

X : 10 $\mu$ S/div

Y : 0.2V/div

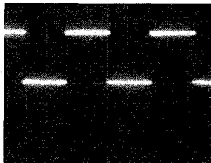

At normal PLAYBACK

X : 10 $\mu$ S/div

Y : 0.2V/div

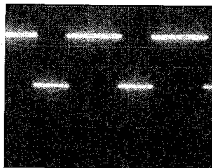

AI PLAYBACK with OFFSET

X : 10 $\mu$ S/div

Y : 0.2V/div

## ELECTRICAL MEASUREMENTS AND ADJUSTMENTS

### Tape speed adjustment (PM03 PCB)

1. Connect frequency counter to analog L- or R-output.
2. Playback on side A 3.15kHz(3kHz) signal from wow & flutter test cassette.
3. Adjust RS02 for frequency reading between 3145Hz(2990Hz) and 3155Hz(3010Hz).
4. Play back 3.15kHz(3kHz) at side B.
5. Adjust RS08 for reading between 3145Hz(2990Hz) and 3155Hz(3010Hz).

#### NOTE:

If the adjustment of the unit is not made precisely and rotation error higher than a specified value occurs, the servo is not locked during playback of a DCC tape and the signals will be muted. This condition (locked or not locked) can be monitored at speed terminal (#3) of JW06. (Refer to photo.) Under normal locked condition, deflection of the speed signal is less than 0.5mS.

### Quick sensor adjustment (PM03 PCB)

1. Connect DC-voltmeter between 3-J031 and ground.
2. Use CC Maxwell UD190.  
(Bad tape with respect to light reflection)
3. Wind tape until leader is passed.
4. Press PLAY.
5. Adjust R036 for DC reading of 1V.  
If don't get 1V at the maximum adjustment, leave the maximum point.

### Analog playback frequency response adjustment (PG03 PCB)

1. Play back 40Hz, 1kHz, 14kHz signals on test tape TCC 183C (-24dB).
2. Adjust each trimming resistor R645(L) and R646(R) so that 40Hz signal level shows within 0 ~ 1dB from 1kHz reference level.
3. Adjust each trimming resistor R643(L) and R644(R) so that 14kHz signal level shows within 0 ~ 1dB from 1kHz reference level.

### Playback output adjustment (Dolby) (PG03 PCB)

1. Connect AC-voltmeter between 1-J601 and 2-J601 for R-channel and 3-J601 and 2-J601 for L-channel.
2. Playback Dolby test cassette.
3. Adjust R633 (L) and R634 (R) for AC reading of 389 mV.

### Level meter sensitivity adjustment (PG03 PCB)

1. Connect a 1kHz (-12dB) digital signal (44.1kHz) to the digital terminal.
2. Set unit to REC PAUSE mode.
3. Adjust each trimming resistor RL05(L), and RL06(R) until meter lights up -10dB point then lights down -12dB point.
4. After the above adjustment, playback the Dolby Test Tape, check the meter lights on 0dB point.

#### NOTE:

If the meter lights on except 0dB point, adjust again from the first step.

### VCO free run frequency adjustment (PZ03 PCB)

1. Turn the power switch ON. (Don't input any digital signal.)
2. Make sure the frequency on the test point J442, and adjust the trimming resistor R455 to 7.5MHz  $\pm$  0.1MHz.

#### NOTE:

If this adjustment is not performed properly, the sync signal is not locked with an outside one.

This frequency must be checked carefully when replacing the IC Q441, Q443 and Q444.

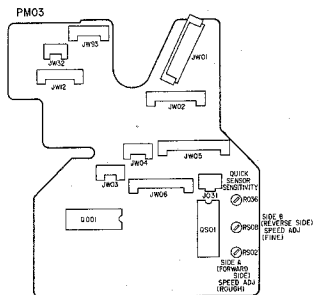

PG03

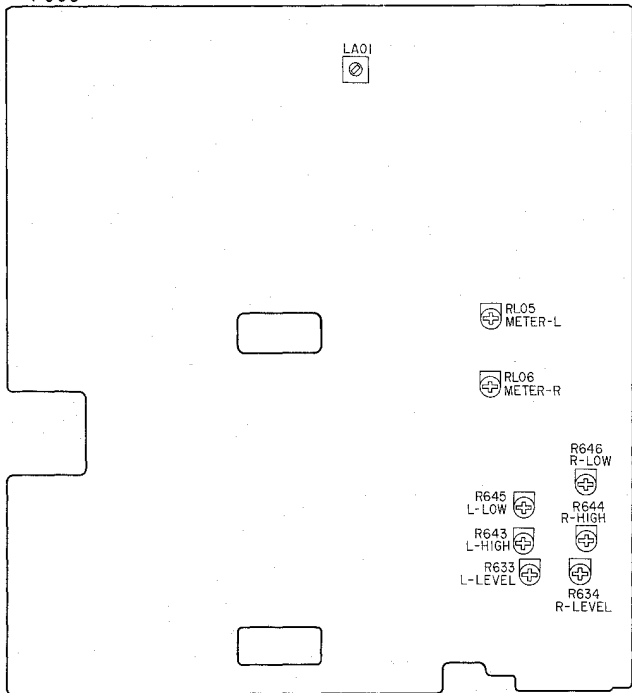

PZ03

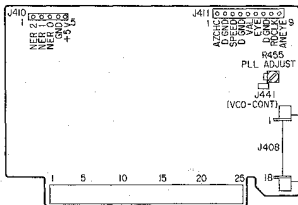

### SET EXPLODED VIEW AND PARTS LIST

REF. DESIG.	PART NO.	DESCRIPTION
002B	4822 443 41205	FRONT PANEL AL(GL) (DD-92)
	4822 443 41206	FRONT PANEL AL(BL) (DD-82)
003B		BUSHING FOR MECHA BUTTON (DD-92)
		BUSHING FOR MECHA BUTTON (DD-82)
004B	4822 459 10972	BADGE FOR MARANTZ(GOLD) (DD-92)
	4822 459 10943	BADGE FOR MARANTZ(GOLD) (DD-82)
005B	4822 403 70836	BRACKET FOR FRONT PANEL
011B	4822 381 11381	LENS FOR IR-SENSOR
012B	4822 381 11382	LENS FOR STANDBY
013B	4822 450 62012	WINDOW FOR FL DISPLAY
020B	4822 454 21082	ESCUTCHEON FOR TLAY DOOR (DD-92)
	4822 454 21083	ESCUTCHEON FOR TLAY DOOR (DD-82)
021B	4822 502 21295	ADJUSTER FOR TRAY + ESC. (DD-92)
	4822 502 21296	ADJUSTER FOR TRAY + ESC. (DD-82)
101B	4822 464 50953	FRONT CHASSIS (DD-92)
	4822 464 50954	FRONT CHASSIS (DD-82)
111B	4822 410 62432	BUTTON ASSY. FOR SUB CODE (DD-92)
	4822 410 62434	BUTTON ASSY. FOR SUB CODE (DD-82)
121B	4822 410 62433	MODE BUTTON ASSY. (DD-92)
	4822 410 62435	MODE BUTTON ASSY. (DD-82)
131B	4822 403 70834	MOVEMENT ASSY. MECHA BUTTON (DD-92)
	4822 403 70835	MOVEMENT ASSY. MECHA BUTTON (DD-82)
221B	4822 462 71899	CAP ASSY. (PLAY BUTTON)(DD-92)
	4822 462 71907	CAP ASSY. (PLAY BUTTON)(DD-82)
231B	4822 462 71901	CAP ASSY. (PREVIOUS BUTTON) (DD-92)
	4822 462 71908	CAP ASSY. (PREVIOUS BUTTON) (DD-82)
241B	4822 462 71902	CAP ASSY. (NEXT BUTTON)(DD-92)
	4822 462 71909	CAP ASSY. (NEXT BUTTON)(DD-82)
251B	4822 462 71905	CAP ASSY. (REWIND BUTTON)(DD-92)
	4822 462 71913	CAP ASSY. (REWIND BUTTON)(DD-82)
261B	4822 462 71903	CAP ASSY. (STOP BUTTON)(DD-92)
	4822 462 71911	CAP ASSY. (STOP BUTTON)(DD-82)
271B	4822 462 71904	CAP ASSY. (PAUSE BUTTON)(DD-92)
	4822 462 71912	CAP ASSY. (PAUSE BUTTON)(DD-82)
281B	4822 462 71906	CAP ASSY. (WIND BUTTON)(DD-92)
	4822 462 71914	CAP ASSY. (WIND BUTTON)(DD-82)
301B	4822 413 41641	KNOB FOR REC VR. (DD-92)
	4822 413 31572	KNOB FOR REC VR. (DD-82)
302B	4822 413 41642	KNOB FOR BL/SEL/LEV/TIM/DOLBY (DD-92)
	4822 413 31573	KNOB FOR BL/SEL/LEV/TIM/DOLBY (DD-82)
303B	4822 410 60358	BUTTON FOR POWER SW. (DD-92)
	4822 410 60194	BUTTON FOR POWER SW. (DD-82)
401B	4822 256 92006	HOLDER FOR FL DISPLAY
402B	4822 454 12431	STICKER
405B	4822 255 41281	HOLDER FOR SANDBY LED
002D	4822 447 50121	SIDE DIECAST PANEL (DD-92)
011D	4822 502 12511	B.T. SCREW (W/W) (DD-82) [01]
	4822 501 11008	B.T. SCREW (W/W) (DD-82) [02/05/07]
012D	4822 444 60607	CAP FOR SIDE PANEL SCREW(DD-92)
009G	4822 462 41993	LEG
025G	4822 502 12512	B.T.SCREW (W/W)
040G	4822 403 70833	LINK FOR POWER BUTTON

REF. DESIG.	PART NO.	DESCRIPTION
		<b>PACKING</b>
001T	4822 736 21627	USER MANUAL (DD-92)
	4822 736 21628	USER MANUAL (DD-82)
Z001	4822 321 22611	RCA CONNECTIVE CORD (GOLD)
Z003	4822 218 30667	REMOTE COMMNDER (DD-92)
	4822 218 30668	REMOTE COMMNDER (DD-82)
Z004	4822 138 10292	BATTERY
Z005	4822 267 31183	JACK, AC ADAPTER [01]
AW001	4822 321 10932	A.C.POWER CORD 2.5A 250V [01/02]
	4822 321 10915	A.C.POWER CORD 2.5A 250V [05]
	4822 321 10934	A.C.POWER CORD 2.5A 250V [07]
001N	4822 691 20815	TRAY MECHANISM ASSY(GL) (DD-92)
	4822 443 63788	TRAY MECHANISM ASSY(BL) (DD-82)
005N	4822 403 70784	ARM KIT
021N	4822 403 70781	ARM
022N	4822 403 70792	ARM
025N	4822 403 70837	GUIDE
027N	4822 401 11486	CLAMPER
029N	4822 522 33306	GEAR
031N	4822 443 63817	CASE (GL) (DD-92)
	4822 443 63789	CASE (BL) (DD-82)
033N	4822 403 70785	RETAINER
039N	4822 492 33359	SPRING
041N	4822 492 33361	SPRING
043N	4822 492 33362	SPRING
045N	4822 492 33363	SPRING
047N	4822 443 63791	MOVEMENT
049N	4822 403 70787	PAD
051N	4822 528 40349	PULLEY
053N	4822 358 31232	BELT
055N	4822 403 70788	LEVER
057N	4822 403 70789	LEVER
061N	4822 464 50941	FRAME
073N	4822 520 40293	BALL
075N	4822 532 21196	FLAT WASHER, L
077N	4822 462 71896	STOPPER WASHER
079N	4822 528 40352	PULLEY
087N	4822 502 12245	P.H.M. SCREW
089N	4822 502 12526	P.H.M. SCREW
091N	4822 401 11485	CLAMPER
093N	4822 462 71886	STOPPER WASHER
094N	4822 528 40351	PULLEY
095N	4822 532 12233	WASHER
096N	4822 532 12233	WASHER
097N	4822 492 71237	LEAF SPRING FOR SLIDER OPEN
098N	4822 492 71236	LEAF SPRING FOR ESD
099N	4822 358 31233	BELT
110N	4822 466 62293	PROTECTOR, CASSETTE CLAMPER SPRING
118N	4822 532 12205	WASHER FOR LEVER
001M	4822 691 20777	MECHANISM ASSY
M051	4822 361 60467	D.C.MOTOR, 8V TRAY
S051	4822 277 21132	SLIDE SWITCH, CLOSE
S052	4822 277 21132	SLIDE SWITCH, OPEN

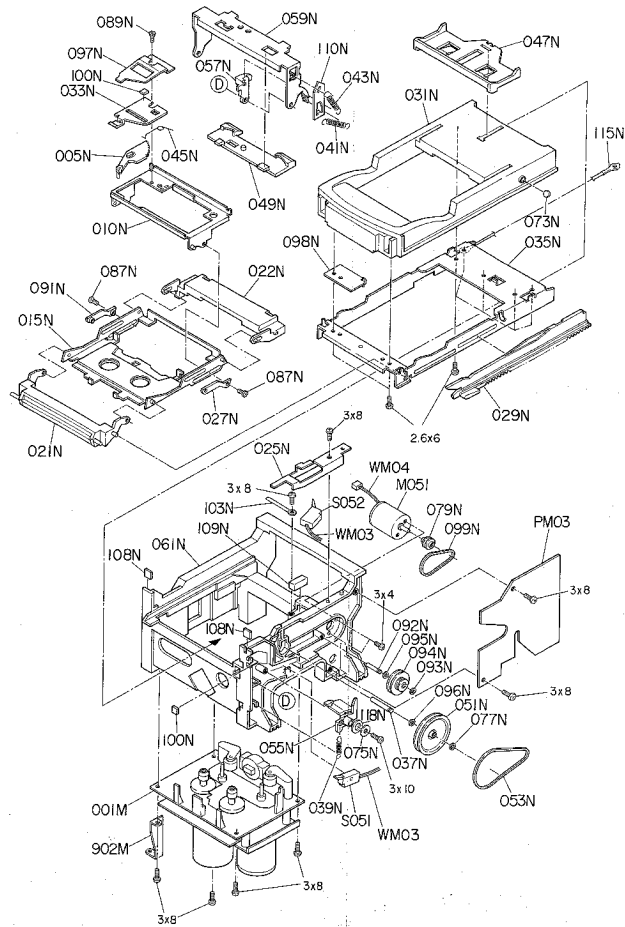
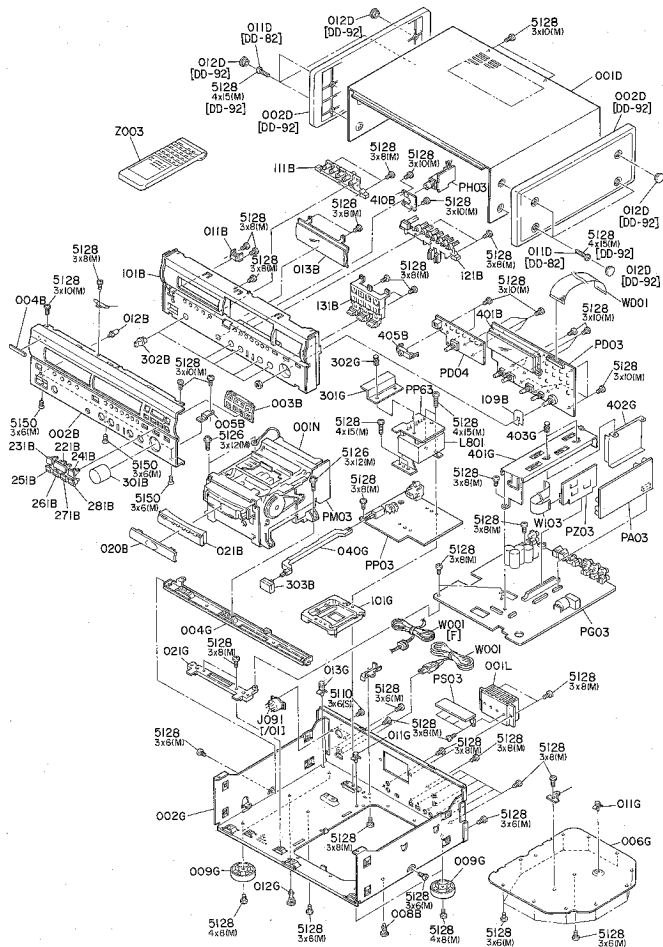



DECK EXPLODED VIEW AND PARTS LIST

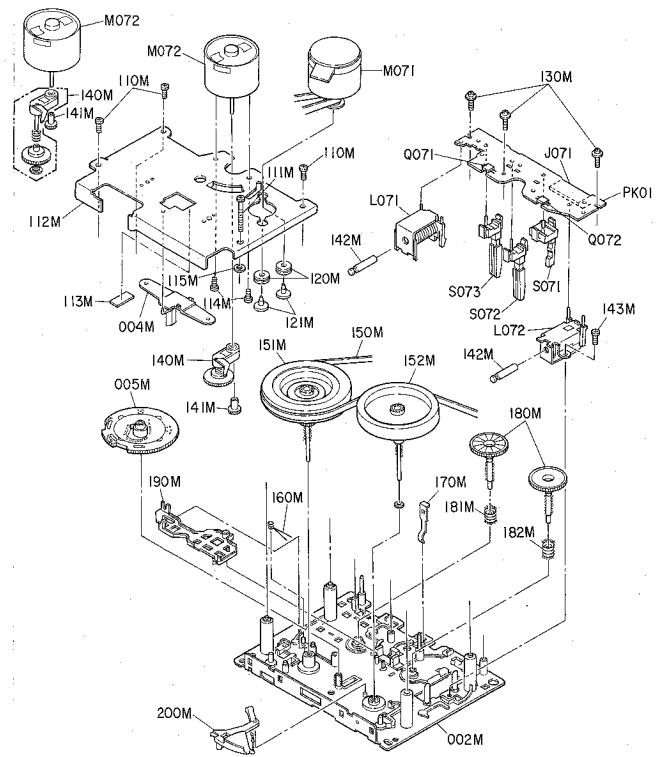
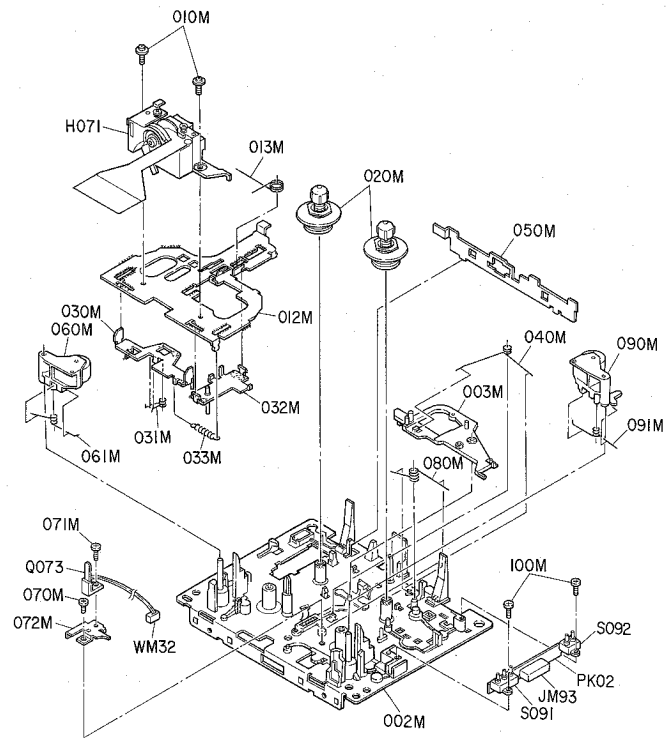

REF. DESIG.	PART NO.	DESCRIPTION
001M	4822 691 20777	MECHANISM ASSY
002M	4822 464 50942	MECHANISM BASE
003M	4822 403 70794	BRAKE LEVER
004M	4822 403 70786	SUSTAINER, THRUST RETAINER
005M	4822 522 33307	MAIN GEAR
010M	4822 502 21266	SCREW, HEAD ASSY
012M	4822 464 50955	HEAD CHASSIS
013M	4822 492 33364	SPRING, HEAD CHASSIS
020M	4822 528 10665	REEL, DAJ
030M	4822 403 70839	REVERS LEVER
031M	4822 492 52341	SPRING, HEAD PRESS
033M	4822 492 33365	LEVER SPRING
040M	4822 492 33366	SPRING, BRAKE LEVER
060M	4822 528 81484	PINCH-ROLLEA (R)
061M	4822 492 71233	SPRING, FOR PINCHROLLEA(R)
070M	4822 502 21267	SPRING, FOR SENSOR RETAINOR
071M	4822 502 21268	SPRING, FOR END SENSOR
090M	4822 492 33367	SPRING, HEAD CHASSIS
090M	4822 528 81485	PINCH ROLLER ASSY(F)
091M	4822 492 71234	SPRING FOR PINCHROLLEA(F)
100M	4822 502 21269	SPRING, FOR DCC SENSOR SW
110M	4822 502 21271	SPRING, FOR MOTOR BASE
111M	4822 502 21272	SPRING, FOR MOTOR BASE
112M	4822 403 70838	MOTOR BRACKET
113M	4822 532 12232	SPACER
114M	4822 502 21273	SPRING, FOR REEL MOTOR
115M	4822 532 12236	WASHER
120M	4822 462 71885	BUFFER FOR DC MOTOR
121M	4822 502 21274	SCREW FOR DC MOTOR
130M	4822 502 21275	SCREW FOR SWITCH PCB
140M	4822 522 33308	IDOL GEAR
141M	4822 522 33309	REEL MOTOR GEAR
143M	4822 502 21265	SCREW FOR BRAKE SOLENOID
150M	4822 358 31234	CAPSTAN BELT
151M	4822 528 60402	FLY WHEEL(F)
152M	4822 528 60403	FLY WHEEL(R)
160M	4822 492 71236	SPRING
170M	4822 492 71302	LEAF SPRING
180M	4822 522 33311	GEAR
181M	4822 492 33366	SPRING
182M	4822 492 33369	SPRING
190M	4822 403 70791	LEVER
200M	4822 403 70792	LEVER
D071	4822 130 32778	DIODE TRIGER 1S133TA
D072	4822 130 32778	DIODE TRIGER 1S133TA
H071	4822 403 70793	HEAD ASSY (HEAD BLOCK)
H702	4822 249 10474	REC/PLAY DCC 20CH HEAD
L071	4822 281 50177	SOLENOID COIL, TRIGER
L072	4822 281 50176	SOLENOID COIL, BRAKE
M071	4822 361 21589	D.C.MOTOR, 12V MAIN (CAPSTAN)
M072	4822 361 21588	D.C.MOTOR, 8V REEL (FWD/REV)
Q071	4822 130 83233	PHOTO UNIT TAKE-UP GP2S06BC
Q072	4822 130 83233	PHOTO UNIT SUPPLY GP2S06BC
Q073	4822 130 83232	PHOTO UNIT QUICK SENSOR SP1-306-03
S071	4822 271 30789	MINI SWITCH MODE
S072	4822 271 30791	MINI SWITCH TAPE IN
S073	4822 271 30791	MINI SWITCH CrO2
S091	4822 276 13345	PUSH SWITCH LENGTH
S092	4822 176 13344	PUSH SWITCH DCC

REF. DESIG.	PART NO.	DESCRIPTION
-------------	----------	-------------

# ELECTRICAL PARTS LIST

## ASSIGNMENT OF COMMON PARTS CODES.

### RESISTOR

**R\*\*\*:** (1) GD05---140, Carbon film fixed resistor,  $\pm 5\%$ , 1/4W  
**R\*\*:** (2) GD05---160, Carbon film fixed resistor,  $\pm 5\%$ , 1/6W

① --- Resistance value

### Examples

① Resistance value  
 0.1 $\Omega$  ... 001    10 $\Omega$  ... 100    1k $\Omega$  ... 102    100k $\Omega$  ... 104  
 0.5 $\Omega$  ... 005    18 $\Omega$  ... 180    2.7k $\Omega$  ... 272    680k $\Omega$  ... 684  
 1 $\Omega$  ... 010    100 $\Omega$  ... 101    10k $\Omega$  ... 103    1M $\Omega$  ... 106  
 6.8 $\Omega$  ... 068    390 $\Omega$  ... 391    22k $\Omega$  ... 223    4.7M $\Omega$  ... 476

(Note) Please distinguish 1/4W from 1/6W by the shape of parts used actually.

### C\*\*\*: CERAMIC CAP.

(1) DD1---370, Ceramic condenser  
 Disc type  
 Temp. coeff. P350 --- N1000, 50V

①②  
 Capacity value  
 Tolerance

### Examples

① Tolerance (Capacity deviation)  
 $\pm 0.25\text{pF} \dots 0$   
 $\pm 0.5\text{pF} \dots 1$   
 $\pm 5\% \dots 5$

\* Tolerance of COMMON PARTS handled here are as follows.

0.5pF ~ 5pF ...  $\pm 0.25\text{pF}$   
 6pF ~ 10pF ...  $\pm 0.5\text{pF}$   
 12pF ~ 560pF ...  $\pm 5\text{pF}$   
 ② Capacity value  
 0.5pF ... 005    3pF ... 030    100pF ... 101  
 1pF ... 010    10pF ... 100    220pF ... 221  
 1.5pF ... 015    47pF ... 470    560pF ... 561

### C\*\*\*: CERAMIC CAP.

(1) DK16---300, High dielectric constant ceramic condenser  
 Disc type  
 Temp. chara. 2B4, 50V

①  
 Capacity value

### Examples

② Capacity value  
 100pF ... 101    1000pF ... 102    10000pF ... 103  
 470pF ... 471    2200pF ... 222

### C\*\*\*: ELECTROLY CAP. ( $\frac{\square}{\square}$ ), FILM CAP. ( $\frac{\square}{\square}$ )

(1) EA---10, Electrolytic condenser  
 One-way lead type, Tolerance  $\pm 20\%$

①②  
 Dielectric strength  
 Capacity value

### Examples

① Capacity value  
 0.1 $\mu\text{F}$  ... 104    4.7 $\mu\text{F}$  ... 475    100 $\mu\text{F}$  ... 107  
 0.33 $\mu\text{F}$  ... 334    10 $\mu\text{F}$  ... 106    330 $\mu\text{F}$  ... 337  
 1 $\mu\text{F}$  ... 105    22 $\mu\text{F}$  ... 228    1100 $\mu\text{F}$  ... 108  
 2200 $\mu\text{F}$  ... 228

② Working voltage  
 6.3V ... 006    25V ... 026  
 10V ... 010    35V ... 036  
 16V ... 016    50V ... 050

(2) DF15---350, Plastic film condenser  
 One-way type, Mylar  $\pm 5\%$  50V

①  
 Capacity value

### Examples

① Capacity value  
 0.001 $\mu\text{F}$  (1000pF) ... 102    0.1 $\mu\text{F}$  ... 104  
 0.001 $\mu\text{F}$  ... 102    0.56 $\mu\text{F}$  ... 564  
 0.01 $\mu\text{F}$  ... 103    1 $\mu\text{F}$  ... 105  
 0.015 $\mu\text{F}$  ... 153

REF. DESIG.	PART NO.	DESCRIPTION
		<b>PA03-AD/DA CIRCUIT BOARD</b>
		<b>PA03-CAPACITORS</b>
C202	4822 126 11687	CERAMIC 0.1 $\mu\text{F}$ +80% -20% CHIP
C203	4822 124 22237	ELECT 10pF 16V
C204	4822 126 11687	CERAMIC 0.1 $\mu\text{F}$ +80% -20% CHIP
C205	4822 124 22237	ELECT 10pF 16V
C206	4822 124 22237	ELECT 10pF 16V
C207	4822 126 11687	CERAMIC 0.1 $\mu\text{F}$ +80% -20% CHIP
C208	4822 124 90352	ELECT 10pF 16V
C210	4822 126 11687	CERAMIC 0.1 $\mu\text{F}$ +80% -20% CHIP
C211	4822 124 22237	ELECT 10pF 16V
C212	?	
C214	4822 126 11687	CERAMIC 0.1 $\mu\text{F}$ +80% -20% CHIP
C215	4822 124 23511	ELECT 100pF 25V
C216	4822 126 11687	CERAMIC 0.1 $\mu\text{F}$ +80% -20% CHIP
C217	4822 124 23511	ELECT 100pF 25V
C218	?	
C219	4822 126 11687	CERAMIC 0.1 $\mu\text{F}$ +80% -20% CHIP
C220	?	
C221	4822 124 90389	ELECT 4.7 $\mu\text{F}$ 25V
C222	4822 124 90389	ELECT 4.7 $\mu\text{F}$ 25V
C225	?	
C228	4822 126 11728	ELECT 220 $\mu\text{F}$ 16V
C231	4822 124 90389	ELECT 4.7 $\mu\text{F}$ 25V
C232	4822 124 90389	ELECT 4.7 $\mu\text{F}$ 25V
C236	4822 126 11687	CERAMIC 0.1 $\mu\text{F}$ +80% -20% CHIP
C301	4822 126 11687	CERAMIC 0.1 $\mu\text{F}$ +80% -20% CHIP
C302	4822 124 41537	ELECT 220pF 6.3V
C305	4822 124 41539	ELECT 47 $\mu\text{F}$ 16V
C306	4822 124 41539	ELECT 47 $\mu\text{F}$ 16V
C309	4822 124 41537	ELECT 220pF 6.3V
C310	4822 124 41537	ELECT 220pF 6.3V
C329	4822 126 12523	CERAMIC 56PF $\pm 5\%$ CHIP
C330	4822 126 12523	CERAMIC 56PF $\pm 5\%$ CHIP
C333	5322 122 32336	FILM 560PF $\pm 5\%$ 50V
C334	5322 122 32336	FILM 560PF $\pm 5\%$ 50V
C335	4822 126 11728	ELECT 220pF 16V
C336	4822 126 11728	ELECT 220pF 16V
C343	?	
C347	4822 121 41857	FILM 0.01 $\mu\text{F}$ $\pm 10\%$
C346	?	
C347	4822 124 90364	ELECT 220 $\mu\text{F}$ 16V
C348	4822 124 90364	ELECT 220 $\mu\text{F}$ 16V
C349	4822 126 11728	ELECT 220pF 16V
C350	4822 126 11728	ELECT 220pF 16V
C351	4822 126 11687	CERAMIC 0.1 $\mu\text{F}$ +80% -20% CHIP
C377	4822 126 11687	CERAMIC 0.1 $\mu\text{F}$ +80% -20% CHIP
C379	4822 124 41537	ELECT 220pF 6.3V
C380	4822 124 41537	ELECT 220pF 6.3V
C381	?	
C388	4822 126 11687	CERAMIC 0.1 $\mu\text{F}$ +80% -20% CHIP
C389	4822 124 41537	ELECT 220pF 6.3V
C390	4822 124 41537	ELECT 220pF 6.3V
C391	4822 126 12524	CERAMIC 820PF $\pm 5\%$ CHIP
C392	4822 126 12524	CERAMIC 820PF $\pm 5\%$ CHIP
C393	?	
C394	4822 122 32796	CERAMIC 220PF $\pm 5\%$ CHIP
C396	?	
C397	4822 126 11687	CERAMIC 0.1 $\mu\text{F}$ +80% -20% CHIP
C398	4822 126 11687	CERAMIC 0.1 $\mu\text{F}$ +80% -20% CHIP
		<b>PA03-RESISTORS</b>
R201	4822 117 10148	51 $\Omega$ $\pm 1\%$ 1/10W, CHIP
R204	4822 051 30103	10K $\Omega$ $\pm 5\%$ 1/16W, CHIP
R205	4822 117 10148	51 $\Omega$ $\pm 1\%$ 1/10W, CHIP
R206	4822 117 10149	120 $\Omega$ $\pm 5\%$ 1/2W, CHIP

REF. DESIG.	PART NO.	DESCRIPTION
R207	4822 117 10149	120Ω ± 5% 1/2W, CHIP
▲ R208	4822 111 90967	4.7Ω ± 5% 1/4W, FUSE
R221	4822 051 30104	100KΩ ± 5% 1/16W, CHIP
R222	4822 051 30104	100KΩ ± 5% 1/16W, CHIP
R223	4822 117 10148	51Ω ± 1% 1/10W, CHIP
R224	4822 117 10148	51Ω ± 1% 1/10W, CHIP
R225	4822 117 10149	120Ω ± 5% 1/2W, CHIP
R228	4822 117 10149	120Ω ± 5% 1/2W, CHIP
R229	4822 051 30223	22KΩ ± 5% 1/16W, CHIP
R230	4822 051 30223	22KΩ ± 5% 1/16W, CHIP
R231	4822 051 30222	2.2KΩ ± 5% 1/16W, CHIP
R232	4822 051 30222	2.2KΩ ± 5% 1/16W, CHIP
R233	4822 051 30102	1KΩ ± 5% 1/16W, CHIP
R234	4822 051 30102	1KΩ ± 5% 1/16W, CHIP
R235	4822 116 83211	1.8KΩ ± 5% 1/16W, CHIP
R236	4822 116 83211	1.8KΩ ± 5% 1/16W, CHIP
R237	4822 051 30473	47KΩ ± 5% 1/16W, CHIP
R238	4822 051 30473	47KΩ ± 5% 1/16W, CHIP
▲ R301	4822 111 90967	4.7Ω ± 5% 1/4W, FUSE
R302	4822 051 30105	1MΩ ± 5% 1/16W, CHIP
▲ R304	4822 111 90967	4.7Ω ± 5% 1/4W, FUSE
▲ R305	4822 111 90967	4.7Ω ± 5% 1/4W, FUSE
R306	4822 051 30102	1KΩ ± 5% 1/16W, CHIP
R308	4822 051 30222	2.2KΩ ± 5% 1/16W, CHIP
R309	4822 111 90983	10KΩ ± 1% 1/10W, CHIP
R312	4822 111 90983	10KΩ ± 1% 1/10W, CHIP
R313	4822 116 83255	3.3KΩ ± 1% 1/10W, CHIP
R316	4822 111 90883	10KΩ ± 1% 1/10W, CHIP
R317	4822 111 90883	10KΩ ± 1% 1/10W, CHIP
R318	4822 117 10183	2.6KΩ ± 1% 1/10W, CHIP
R319	4822 117 10183	2.6KΩ ± 1% 1/10W, CHIP
R320	4822 111 90967	4.7Ω ± 5% 1/4W, FUSE
▲ R321	4822 111 90967	4.7Ω ± 5% 1/4W, FUSE
▲ R322	4822 111 90967	4.7Ω ± 5% 1/4W, FUSE
R323	4822 117 10183	2.6KΩ ± 1% 1/10W, CHIP
R324	4822 117 10183	2.6KΩ ± 1% 1/10W, CHIP
R325	4822 051 30102	1KΩ ± 5% 1/16W, CHIP
R326	4822 051 30102	1KΩ ± 5% 1/16W, CHIP
R327	4822 051 30682	6.8KΩ ± 5% 1/16W, CHIP
R328	4822 051 30682	6.8KΩ ± 5% 1/16W, CHIP
R329	4822 051 30222	2.2KΩ ± 5% 1/16W, CHIP
R330	4822 051 30222	2.2KΩ ± 5% 1/16W, CHIP
R331	4822 051 30101	100Ω ± 5% 1/16W, CHIP
R332	4822 051 30101	100Ω ± 5% 1/16W, CHIP
R333	4822 051 30471	470Ω ± 5% 1/16W, CHIP
R334	4822 051 30471	470Ω ± 5% 1/16W, CHIP
R335	4822 117 10154	10MΩ ± 5% 1/16W, CHIP
R336	4822 117 10154	10MΩ ± 5% 1/16W, CHIP
▲ R337	4822 115 90166	10Ω ± 2% 1/4W, FUSE
▲ R340	4822 051 30101	100Ω ± 5% 1/16W, CHIP
R341	4822 051 30101	100Ω ± 5% 1/16W, CHIP
R342	4822 051 30101	100Ω ± 5% 1/16W, CHIP
R343	4822 051 30682	6.8KΩ ± 5% 1/16W, CHIP
R344	4822 051 30682	6.8KΩ ± 5% 1/16W, CHIP
R345	4822 051 30101	100Ω ± 5% 1/16W, CHIP
R346	4822 051 30101	100Ω ± 5% 1/16W, CHIP
R347	4822 051 30223	22KΩ ± 5% 1/16W, CHIP
R348	4822 051 30223	22KΩ ± 5% 1/16W, CHIP
R349	4822 051 30473	47KΩ ± 5% 1/16W, CHIP
R350	4822 051 30153	15KΩ ± 5% 1/16W, CHIP
R351	4822 051 30104	100KΩ ± 5% 1/16W, CHIP
R352	4822 116 82487	0Ω ± 5% 1/16W, CHIP
R359	4822 116 82487	0Ω ± 5% 1/16W, CHIP
R360	4822 116 82487	0Ω ± 5% 1/16W, CHIP

REF. DESIG.	PART NO.	DESCRIPTION
R363	4822 051 30223	22KΩ ± 5% 1/16W, CHIP
R364	4822 051 30223	22KΩ ± 5% 1/16W, CHIP
R365	4822 051 30103	10KΩ ± 5% 1/16W, CHIP
R366	4822 051 30103	10KΩ ± 5% 1/16W, CHIP
R371	4822 117 10154	10MΩ ± 5% 1/16W, CHIP
R374	4822 051 30103	10KΩ ± 5% 1/16W, CHIP
R376	4822 051 30103	10KΩ ± 5% 1/16W, CHIP
▲ R381	4822 111 90967	4.7Ω ± 5% 1/4W, FUSE
▲ R384	4822 116 83253	1.5KΩ ± 1% 1/10W, CHIP
R385	4822 116 83253	1.5KΩ ± 1% 1/10W, CHIP
R386	4822 116 83253	1.5KΩ ± 1% 1/10W, CHIP
R387	4822 116 83255	3.3KΩ ± 1% 1/10W, CHIP
R388	4822 116 83255	3.3KΩ ± 1% 1/10W, CHIP
R389	4822 116 83352	560Ω ± 5% 1/10W, CHIP
R390	4822 116 83352	560Ω ± 5% 1/10W, CHIP
R391	4822 116 83255	3.3KΩ ± 1% 1/10W, CHIP
R392	4822 116 83255	3.3KΩ ± 1% 1/10W, CHIP
R393	4822 111 91355	13KΩ ± 1% 1/10W, CHIP
R396	4822 111 90967	4.7Ω ± 5% 1/4W, FUSE
▲ R397	4822 111 90967	4.7Ω ± 5% 1/4W, FUSE
<b>PA03-SEMICONDUCTORS</b>		
D221	4822 130 81395	DIODE, MA714 CHIP
D222	4822 130 81395	DIODE, MA714 CHIP
D301	4822 130 83281	ZENER DIODE, MA9062-M 6.2V CHIP
D302	4822 130 83281	ZENER DIODE, MA9062-M 6.2V CHIP
D303	4822 130 83225	ZENER DIODE, MA8043M CHIP
D304	4822 130 80727	DIODE, MA110 CHIP
D305	4822 130 80727	DIODE, MA110 CHIP
Q201	4822 209 32064	IC, A/D CONVERTER AK5328
Q202	4822 209 31935	IC, TC74HC374AF CHIP
Q203	4822 209 31928	IC, CMOS 74HC00 CHIP
Q204	4822 209 63365	IC, NUM78L05UA CHIP
Q205	4822 209 31903	IC, NUM78L05UA CHIP
Q206	4822 130 60326	DIGITAL TRANSISTOR, DTA144EK
C221	4822 209 83358	IC, NUM072M CHIP
C222	4822 209 83358	IC, NUM072M CHIP
Q301	4822 209 30439	IC, DAC SAA7350 BS CHIP
Q302	4822 209 31906	IC, SM5940FS NPC CHIP
Q303	4822 209 83359	IC, NUM5532M CHIP
Q307	4822 130 42842	TRANSISTOR, 2SK372 (GR, BL)
Q308	4822 130 42842	TRANSISTOR, 2SK372 (GR, BL)
Q309	4822 130 61074	TRANSISTOR, 2SA812(M5B,M6B) CHIP
Q311	4822 130 42842	TRANSISTOR, 2SK372 (GR, BL)
Q314	4822 209 31013	IC, TDA1547 DAC7
Q316	4822 130 62549	TRANSISTOR, 2SD1762 (E, F)
Q317	4822 130 62548	TRANSISTOR, 2SB1185 (E, F)
Q318	4822 130 61074	TRANSISTOR, 2SA812(M5B,M6B) CHIP
<b>PA03-MISCELLANEOUS</b>		
J301	4822 267 31582	PLUG, 6P S6B-XH-A
J302	4822 267 31582	PLUG, 11P S11B-XH-A
J303	4822 267 31582	PLUG, 6P S6B-XH-A
L201	4822 157 53872	CHOKO COIL 10μH
L203	4822 157 53872	CHOKO COIL 10μH
L205	4822 157 53872	CHOKO COIL 10μH
L301	4822 157 53873	CHOKO COIL 100μH
L302	4822 157 53873	CHOKO COIL 100μH

REF. DESIG.	PART NO.	DESCRIPTION
		<b>PD03-FRONT FLD/KEY SW CIRCUIT BOARD</b>
		<b>PD03-CAPACITORS</b>
CD01	4822 124 22318	ELECT 10 $\mu$ F 16V
CD02	4822 122 40617	CERAMIC 0.1 $\mu$ F +80% -20% 50V
CV01	4822 124 22318	ELECT 10 $\mu$ F 16V
CV02	4822 124 22318	ELECT 10 $\mu$ F 16V
		<b>PD03-RESISTORS</b>
GD01	4822 111 92126	47K $\Omega$ X 10 COMPO.
GD02	4822 111 92125	47K $\Omega$ X 9 COMPO.
GD03	4822 111 92124	47K $\Omega$ X 8 COMPO.
GD04	4822 111 92123	47K $\Omega$ X 7 COMPO.
RH01	4822 100 11967	20K $\Omega$ X2 VARIABLE HEAD PHONE VR.
RV01	4822 100 11947	50K $\Omega$ X2 VARIABLE REC VR.
RV02	4822 100 11966	100K $\Omega$ X2 VARIABLE VALANCE VR.
		<b>PD03-SEMICONDUCTORS</b>
DD04	4822 130 33305	DIODE, 1SS175,MA165,1SS254 30V 0.1A
DD07		
OD01	4822 209 31937	MICROPROCESSOR, FRONT $\mu$ PD75238 CHIP
		<b>PD03-MISCELLANEOUS</b>
JD01	4822 265 31036	JACK, CARD FIT TYPE CONNECTOR 25P
SD01	4822 276 20508	PUSH SWITCH
SD03		
SD06	4822 276 20508	PUSH SWITCH
SD08	4822 276 20508	PUSH SWITCH
SD09	4822 276 20508	PUSH SWITCH
SD15		
SD17	4822 276 20508	PUSH SWITCH
SD19		
SD29	4822 276 20508	PUSH SWITCH
SD32	4822 273 10263	ROTARY SWITCH DOLBY SW.
SD33	4822 273 10263	ROTARY SWITCH INPUT SELECTOR
VD01	4822 130 91212	FL DISPLAY UNIT FIP16BM7R
WD01	4822 321 61852	JUMPER LEAD, 25P CARD TYPE
XD01	4822 242 72194	CERAMIC VIB. 4.19MHZ
		<b>PD04-IR-SENSOR/KEY SW CIRCUIT BOARD</b>
		<b>PD04-CAPACITOR</b>
CD03	4822 124 80397	ELECT 47 $\mu$ F 16V
		<b>PD04-SEMICONDUCTORS</b>
DD01	4822 130 80326	L.E.D. LT3D88 RED
OD02	4822 130 81254	PHOTO UNIT, GP1U520X 36.0KHZ
		<b>PD04-MISCELLANEOUS</b>
SD10		
SD14	4822 276 20508	PUSH SWITCH
SD31	4822 273 10258	ROTARY SWITCH TIMER

REF. DESIG.	PART NO.	DESCRIPTION
		<b>PG03-MAIN CIRCUIT BOARD</b>
		<b>PG03-CAPACITORS</b>
CA01	4822 124 90352	ELECT 10 $\mu$ F 16V
CA02	4822 122 40589	CERAMIC 0.047 $\mu$ F $\pm$ 5% 50V
CA04	4822 122 40617	CERAMIC 0.1 $\mu$ F +80% -20% 50V
CA05	4822 122 40589	CERAMIC 0.047 $\mu$ F $\pm$ 5% 50V
CA06	4822 124 90382	ELECT 22 $\mu$ F 50V
CA07	4822 126 10364	CERAMIC 100PF $\pm$ 10%
CA08	4822 122 40617	CERAMIC 0.1 $\mu$ F +80% -20% 50V
CA09	4822 124 90362	ELECT 22 $\mu$ F 50V
CA12	4822 122 40617	CERAMIC 0.1 $\mu$ F +80% -20% 50V
CA13	4822 126 10364	CERAMIC 100PF $\pm$ 10%
CA17		
CA19	4822 122 40617	CERAMIC 0.1 $\mu$ F +80% -20% 50V
CH01	4822 124 90364	ELECT 220 $\mu$ F 16V
CH02	4822 124 90364	ELECT 220 $\mu$ F 16V
CH03	4822 124 22274	ELECT 4.7 $\mu$ F 50V
CH04	4822 124 22274	ELECT 4.7 $\mu$ F 50V
CL01		
CL04	4822 124 90352	ELECT 10 $\mu$ F 16V
CL05	4822 124 90354	ELECT 100 $\mu$ F 16V
CL06	4822 124 90354	ELECT 100 $\mu$ F 16V
CM01	4822 124 90354	ELECT 100 $\mu$ F 16V
CM21	4822 122 40589	CERAMIC 0.047 $\mu$ F $\pm$ 20% 50V
CM22	4822 122 40589	CERAMIC 0.047 $\mu$ F $\pm$ 20% 50V
CM51	4822 122 40589	CERAMIC 0.047 $\mu$ F $\pm$ 20% 50V
CM52	4822 122 40589	CERAMIC 0.047 $\mu$ F $\pm$ 20% 50V
CG01	4822 124 22703	ELECT 0.22 $\mu$ F 50V
CG02	4822 124 22273	ELECT 0.47 $\mu$ F 50V
CG04	4822 122 30103	CERAMIC 0.022 $\mu$ F +80% -20% 50V
CG08	4822 124 90354	ELECT 100 $\mu$ F 16V
CG10	4822 122 40588	CERAMIC 0.022 $\mu$ F $\pm$ 20% 50V
CG21	4822 126 10364	CERAMIC 100PF $\pm$ 10%
CG22	4822 122 30103	CERAMIC 0.022 $\mu$ F +80% -20% 50V
CG51	4822 124 90352	ELECT 10 $\mu$ F 16V
CG52	4822 124 90352	ELECT 10 $\mu$ F 16V
CG53	4822 124 41539	ELECT 47 $\mu$ F 16V
CG54	4822 124 41539	ELECT 47 $\mu$ F 16V
CG55	4822 124 90352	ELECT 10 $\mu$ F 16V
CR01	4822 124 90352	ELECT 10 $\mu$ F 16V
CR02	4822 122 30103	CERAMIC 0.022 $\mu$ F +80% -20% 50V
CR03	4822 122 40617	CERAMIC 0.1 $\mu$ F +80% -20% 50V
CR04	4822 126 10364	CERAMIC 100PF $\pm$ 10%
CR06	4822 122 40617	CERAMIC 0.1 $\mu$ F +80% -20% 50V
CU01	4822 124 41539	ELECT 47 $\mu$ F 16V
CU02	4822 122 40617	CERAMIC 0.1 $\mu$ F +80% -20% 50V
CU21	4822 124 41539	ELECT 47 $\mu$ F 16V
CU22	4822 122 40617	CERAMIC 0.1 $\mu$ F +80% -20% 50V
CU31	4822 124 41543	ELECT 1 $\mu$ F 50V
CU51	4822 124 90354	ELECT 100 $\mu$ F 16V
CU52	4822 124 22571	ELECT 10 $\mu$ F 50V
CU53	4822 124 90357	ELECT 2.2 $\mu$ F 50V
CU54	4822 124 90354	ELECT 100 $\mu$ F 16V
CU81	4822 124 41539	ELECT 47 $\mu$ F 6V
CU82	4822 122 40617	CERAMIC 0.1 $\mu$ F +80% -20% 50V
C031	4822 124 22274	ELECT 4.7 $\mu$ F 50V
C032	4822 124 90352	ELECT 10 $\mu$ F 16V
C033	4822 124 90357	ELECT 2.2 $\mu$ F 50V
C451	4822 124 22277	ELECT 470 $\mu$ F 16V
C601		
C604	4822 124 22274	ELECT 4.7 $\mu$ F 50V

REF. DESIG.	PART NO.	DESCRIPTION
C609	4822 124 23445	ELECT 0.56μF 50V
C610	4822 124 23445	ELECT 0.56μF 50V
C613	4822 124 23112	ELECT 10μF 16V
C622	4822 124 90354	ELECT 100μF 16V
C623	4822 124 90354	ELECT 100μF 16V
C635	4822 124 90364	ELECT 220μF 16V
C636	4822 124 90364	ELECT 220μF 16V
C639	4822 126 10408	CERAMIC 220PF ± 10%
C640	4822 126 10408	CERAMIC 220PF ± 10%
C721	4822 124 22274	ELECT 4.7μF 50V
C722	4822 124 22274	ELECT 4.7μF 50V
C726	4822 124 41539	ELECT 47μF 16V
C727	4822 124 41539	ELECT 47μF 16V
C728	4822 124 90364	ELECT 220μF 16V
C729	4822 124 90364	ELECT 220μF 16V
C731	4822 124 90354	ELECT 100μF 16V
C732	4822 122 40589	CERAMIC 0.047μF ± 20% 50V
C733	4822 122 40589	CERAMIC 0.047μF ± 20% 50V
C751	4822 126 10364	CERAMIC 100PF ± 10%
C752	4822 126 10364	CERAMIC 100PF ± 10%
C753	4822 124 22274	ELECT 4.7μF 50V
C754	4822 124 22274	ELECT 4.7μF 50V
C756	4822 124 90364	ELECT 220μF 16V
C757	4822 124 90364	ELECT 220μF 16V
C761	1	4822 126 10408
C764	1	CERAMIC 220PF ± 10%
C801	4822 124 23518	ELECT 4700μF 35V
C802	4822 124 23518	ELECT 2200μF 35V
C809	4822 124 22571	ELECT 10μF 50V
C810	4822 122 40589	CERAMIC 0.047μF ± 20% 50V
C812	4822 124 90352	ELECT 10μF 16V
C813	4822 124 90352	ELECT 10μF 16V
C841	4822 124 90364	ELECT 220μF 16V
C842	4822 124 90364	ELECT 220μF 16V
C881	4822 124 22277	ELECT 470μF 16V
<b>PG03-RESISTORS</b>		
RA13	4822 050 23909	39Ω ± 5% 1/4W
RA15	4822 050 23909	39Ω ± 5% 1/4W
▲ RH02	4822 115 90166	10Ω ± 2% 1/4W, FUSE
▲ RH04	4822 115 90166	10Ω ± 2% 1/4W, FUSE
RL05	4822 100 20681	2.2KΩ TRIMMING, METER (L)
RL06	4822 100 20681	2.2KΩ TRIMMING, METER (R)
▲ RL09	4822 115 90166	10Ω ± 2% 1/4W, FUSE
▲ RL10	4822 115 90166	10Ω ± 2% 1/4W, FUSE
▲ RM01	4822 053 10228	2.2Ω 1W
▲ RM23	4822 113 90107	4.7Ω ± 5% 1/4W, FUSE
▲ RM57	4822 113 90107	4.7Ω ± 5% 1/4W, FUSE
RM88	4822 116 60355	33Ω ± 5% 1W
▲ RQ17	4822 053 10151	150Ω 1W
▲ RQ61	4822 115 90166	10Ω ± 2% 1/4W, FUSE
▲ RQ62	4822 115 90166	10Ω ± 2% 1/4W, FUSE
RR01	4822 050 21021	100Ω ± 5% 1/4W
R633	4822 100 11351	10KΩ TRIMMING
R634	4822 100 11351	10KΩ TRIMMING
R643	4822 100 11372	47KΩ TRIMMING
R644	4822 100 11372	47KΩ TRIMMING
R645	4822 100 11641	470KΩ TRIMMING
R646	4822 100 11641	470KΩ TRIMMING
▲ R705	4822 115 90166	10Ω ± 2% 1/4W, FUSE
▲ R728	4822 115 90166	10Ω ± 2% 1/4W, FUSE
▲ R729	4822 115 90166	10Ω ± 2% 1/4W, FUSE
R731	4822 100 11948	20KΩ VARIABLE MOTOR DRIVE
▲ R732	4822 111 90967	4.7Ω ± 2% 1/4W, FUSE
▲ R751	4822 115 90166	10Ω ± 2% 1/4W, FUSE

REF. DESIG.	PART NO.	DESCRIPTION
▲ R752	4822 115 90166	10Ω ± 2% 1/4W, FUSE
▲ R801	4822 116 21086	1Ω ± 5% 0.5W, FUSE
▲ R802	4822 116 21088	2.2Ω ± 5% 0.5W, FUSE
▲ R803	1	4822 116 21086
▲ R805	1	4822 116 21086
▲ R806	4822 116 60307	1Ω ± 5% 1/4W, FUSE
▲ R810	4822 115 90166	10Ω ± 2% 1/4W, FUSE
▲ R813	4822 115 90166	10Ω ± 2% 1/4W, FUSE
▲ R814	4822 115 90166	10Ω ± 2% 1/4W, FUSE
<b>PG03-SEMICONDUCTORS</b>		
DH01	4822 130 33305	DIODE, 1SS176,MA165,1SS254 30V 0.1A
DH02	4822 130 33305	DIODE, 1SS176,MA165,1SS254 30V 0.1A
DM01	4822 130 33305	DIODE, 1SS176,MA165,1SS254 30V 0.1A
DM21	4822 130 80132	ZENER DIODE, 3.9V
DM22	4822 130 80273	ZENER DIODE, 8.2V
DM23	4822 130 33305	DIODE, 1SS176,MA165,1SS254 30V 0.1A
DM51	4822 130 80273	ZENER DIODE, 8.2V
DM52	4822 130 33305	DIODE, 1SS176,MA165,1SS254 30V 0.1A
DR01	4822 130 33305	DIODE, 1SS176,MA165,1SS254 30V 0.1A
DU11	4822 130 80132	ZENER DIODE, 3.9V
DU51	4822 130 33305	DIODE, 1SS176,MA165,1SS254 30V 0.1A
DU53	4822 130 33305	DIODE, 1SS176,MA165,1SS254 30V 0.1A
DU61	4822 130 33305	DIODE, 1SS176,MA165,1SS254 30V 0.1A
▲ DU62	4822 130 80839	DIODE, S5688G VRM=400V IO=1A
D641	4822 130 33305	DIODE, 1SS176,MA165,1SS254 30V 0.1A
▲ D701	4822 130 80839	DIODE, S5688G VRM=400V IO=1A
D702	4822 130 33305	DIODE, 1SS176,MA165,1SS254 30V 0.1A
D703	4822 130 33305	DIODE, 1SS176,MA165,1SS254 30V 0.1A
D817	4822 130 80317	ZENER DIODE, 5.1V
D818	4822 130 80273	ZENER DIODE, 8.2V
D819	4822 130 80273	ZENER DIODE, 8.2V
▲ D822	4822 130 80839	DIODE, 1S5688G VRM=400V IO=1A
D823	4822 130 33305	DIODE, 1SS176,MA165,1SS254 30V 0.1A
D824	4822 130 33305	DIODE, 1SS176,MA165,1SS254 30V 0.1A
▲ D828	4822 130 80839	DIODE, S5688G VRM=400V IO=1A
▲ D841	4822 130 80839	DIODE, S5688G VRM=400V IO=1A
QA01	4822 209 63182	IC, 74HCU04
QA02	4822 130 60588	DIGITAL TRANSISTOR, DTC114ES
QA03	4822 130 42715	TRANSISTOR, 2SA608SP, 25A1048, 2SA1309, 2SA933S
QA04	4822 130 42298	TRANSISTOR, 2SC5365P, 2SC2458, 2SC3311, 2SC1740S
QH02	4822 209 61187	IC, BA15218
QH05	1	4822 130 61723
QH08	1	DIGITAL TRANSISTOR, DTC323TS 2.2K
QL01	4822 209 82513	IC, METER AC/DC AMP BA6138
QL02	4822 209 61187	IC, BA15218
QM01	4822 130 61189	DIGITAL TRANSISTOR, DTC114TS
QM02	4822 130 61189	DIGITAL TRANSISTOR, DTC114TS

REF. DESIG.	PART NO.	DESCRIPTION
QM03	4822 130 61725	TRANSISTOR, 2SD2010
QM04	4822 130 61189	DIGITAL TRANSISTOR, DTC114TS
QM21	4822 206 61188	IC, BA6219
QM22	4822 130 61189	DIGITAL TRANSISTOR, DTC114TS
QM51	4822 209 30193	IC, LB1641
QM81	4822 130 61189	DIGITAL TRANSISTOR, DTC114TS
QM84		
QM85	4822 130 60173	TRANSISTOR, 2SC2060(Q,R)
QM86	4822 130 60173	TRANSISTOR, 2SC2060(Q,R)
QM87	4822 130 63188	TRANSISTOR, 2SB1425(E, U)
QQ01	4822 209 83706	IC, BA335PK
QQ03	4822 130 61189	DIGITAL TRANSISTOR, DTC114TS
QQ06		
QQ21	4822 130 42296	TRANSISTOR, 2SC536SP, 2SC2458, 2SC3311, 2SC1740S
QQ51	4822 209 61187	IC, BA15218
QQ52	4822 130 61189	DIGITAL TRANSISTOR, DTC114TS
QR01	4822 130 42715	TRANSISTOR, 2SA608SP, 2SA1048, 2SA1309, 2SA933S
QR02	4822 130 42298	TRANSISTOR, 2SC536SP, 2SC2458, 2SC3311A, 2SC1740S
QR51	4822 130 42594	DIGITAL TRANSISTOR, DTC144ES
QR52	4822 130 42594	DIGITAL TRANSISTOR, DTC144ES
QU01	4822 209 31936	MICROPROCESSOR, MAIN $\mu$ PD75P518GF CHIP
QU02	4822 130 61189	DIGITAL TRANSISTOR, DTC114TS
QU03	4822 130 61227	DIGITAL TRANSISTOR, DTA114ES
QU05		
QU11	4822 130 61227	DIGITAL TRANSISTOR, DTA114ES
QU12	4822 130 61189	DIGITAL TRANSISTOR, DTC114TS
QU14		
QU16	4822 130 61189	DIGITAL TRANSISTOR, DTA114TS
QU17	4822 130 61189	DIGITAL TRANSISTOR, DTC114TS
QU18	4822 130 61227	DIGITAL TRANSISTOR, DTA114ES
QU19	4822 130 42298	TRANSISTOR, 2SC536SP, 2SC2458, 2SC3311, 2SC1740S
QU21	4822 209 31932	IC, 74HC125AP
QU22	4822 130 60586	DIGITAL TRANSISTOR, DTC114ES
QU33	4822 130 42682	DIGITAL TRANSISTOR, DTA144ES
QU41	4822 130 42296	TRANSISTOR, 2SC536SP, 2SC2458, 2SC3311, 2SC1740S
QU52	4822 130 61227	DIGITAL TRANSISTOR, DTA114ES
QU53	4822 130 60588	DIGITAL TRANSISTOR, DTC114ES
QU54	4822 130 42682	DIGITAL TRANSISTOR, DTA144ES
QU55	4822 130 61189	DIGITAL TRANSISTOR, DTC114TS
QU56	4822 130 61189	DIGITAL TRANSISTOR, DTC114TS
QU57	4822 130 61189	DIGITAL TRANSISTOR, DTC114TS
QU61	4822 130 60588	DIGITAL TRANSISTOR, DTC114ES
QU62	4822 130 61227	DIGITAL TRANSISTOR, DTA114ES
QU63	4822 130 61725	TRANSISTOR, 2SD2010
QU64	4822 130 60588	DIGITAL TRANSISTOR, DTC114ES
QU65	4822 130 61227	DIGITAL TRANSISTOR, DTA114ES
QU81	4822 209 31923	IC, EEPROM BR93LC46
Q031	4822 209 31924	IC, TA75358CP
Q601	4822 209 62251	IC, DOLBY/B NR CXA1330
Q602	4822 209 73064	IC, NJM-2368-DD
Q611	4822 130 61189	DIGITAL TRANSISTOR, DTA114TS
Q612	4822 130 60588	DIGITAL TRANSISTOR, DTC114ES
Q613	4822 130 61227	DIGITAL TRANSISTOR, DTA114ES
Q641	4822 130 61723	DIGITAL TRANSISTOR, DTC323TS 2.2K
Q642	4822 130 61723	DIGITAL TRANSISTOR, DTC323TS 2.2K
Q671	4822 130 60588	DIGITAL TRANSISTOR, DTC114ES
Q672	4822 130 60588	DIGITAL TRANSISTOR, DTC114ES

REF. DESIG.	PART NO.	DESCRIPTION
Q701	4822 130 63189	TRANSISTOR, 2SD2159 (U, V)
Q702	4822 130 61189	DIGITAL TRANSISTOR, DTC114TS
Q720	4822 209 61187	IC, BA15218
Q731	4822 209 73287	IC, LB1630
Q751	4822 209 73064	NJM-2068-DD
Q761	4822 130 61892	TRANSISTOR, 2SD2144S (U, V)
Q768		
Q806	4822 130 63189	TRANSISTOR, 2SD2159 (U, V)
Q807	4822 130 63188	TRANSISTOR, 2SB1425 (E, U)
Q809	4822 130 61189	DIGITAL TRANSISTOR, DTC114TS
Q810	4822 130 61189	DIGITAL TRANSISTOR, DTC114TS
Q811	4822 209 31925	IC, PQ05RA11 1A,5V
Q812	4822 209 62941	IC, NJM78M08FA
Q843	4822 130 61189	DIGITAL TRANSISTOR, DTC114TS
		<b>PG03-MISCELLANEOUS</b>
JA01	4822 265 31042	OPTICAL CONNECTOR, PLT102, OUT
JA02	4822 265 31043	OPTICAL CONNECTOR TORX176, IN
JA03	4822 265 31044	RCA JACK, 2P COAX IN/OUT
JR01	4822 267 41009	RCA PIN JACK, 2P ORG
JU02	4822 265 51347	JACK, 25P CARD TYPE
J311	4822 265 31034	JACK, 6P
J312	4822 265 31035	JACK, 11P
J313	4822 265 31034	JACK, 6P
J421	4822 265 31039	JACK, 50P (25X2)
J740	4822 265 31045	RCA JACK W/R GOLD 2P
J741	4822 265 31045	RCA JACK W/R GOLD 2P
J742	4822 265 31045	RCA JACK W/R GOLD 2P
LA01	4822 142 60388	PULSE TRANSFORMER
LA02	4822 157 53813	CHOKE COIL, 10 $\mu$ H
LA03	4822 157 53585	CHOKE COIL, 47 $\mu$ H
L701	4822 280 20183	RELAY, SZ-2103 12V
L711	4822 526 10543	FERRITE CORE
L718		
L719	4822 526 10584	FERRITE CORE
L721	4822 526 10584	FERRITE CORE
SR01	4822 277 21659	SLIDE SWITCH REMOTE SELECT
XU01	4822 242 72194	CERAMIC VIBRATOR, 4.19MHZ
		<b>PM03-TRAY WIRE CONNECTIVE/ SERVO CIRCUIT BOARD</b>
		<b>PM03-CAPACITORS</b>
C001	4822 124 22703	ELECT 0.22 $\mu$ F 50V
C002	4822 124 40721	ELECT 2.2 $\mu$ F 50V
C004	4822 126 12496	CERAMIC 0.01 $\mu$ F +80% -20% 50V
C005	4822 124 41537	ELECT 220 $\mu$ F 6.3V
C006	4822 122 40617	CERAMIC 0.1 $\mu$ F +80% -20% 50V
C007	4822 122 40617	CERAMIC 0.1 $\mu$ F +80% -20% 50V
		<b>PM03-RESISTORS</b>
R502	4822 100 11235	4.7K $\Omega$ TRIMMING, SIDE A
R503	4822 111 92128	130 $\Omega$ THERMISTOR
RS08	4822 100 11452	470 $\Omega$ TRIMMING, SIDE B
R018	4822 116 62752	10K $\Omega$ $\pm$ 1% 1/6W
R019	4822 116 62752	10K $\Omega$ $\pm$ 1% 1/6W
R031	4822 050 21501	150 $\Omega$ $\pm$ 5% 1/4W
R036	4822 100 20539	22K $\Omega$ TRIMMING, Q. SENSOR
		<b>PM03-SEMICONDUCTORS</b>
D001	4822 130 33305	DIODE, 1SS176,MA165,1SS254 30V 0.1A
D002	4822 130 81424	ZENER DIODE, BZV86-2V0

REF. DESIG.	PART NO.	DESCRIPTION
D003	4822 130 81424	ZENER DIODE, BZV86-2V0
Q501	4822 209 63382	IC, 74HC4066
Q502	4822 130 61186	DIGITAL TRANSISTOR, DTC144TS
Q503	4822 130 42594	DIGITAL TRANSISTOR, DTC144ES
Q001	4822 209 31907	IC, NJM2902N
Q011	4822 130 42296	TRANSISTOR, 2SC5635P, 2SC2458, 2SC3311, 2SC1740S
<b>PP03-POWER SUPPLY CIRCUIT BOARD</b>		
<b>PP03-CAPACITORS</b>		
B822	4822 126 11235	COMP. 0.047 $\mu$ F +6.80 $\pm$ 20%
C826	4822 122 30103	CERAMIC 0.022 $\mu$ F +80%-20% 50V
C827	4822 122 30103	CERAMIC 0.022 $\mu$ F +80%-20% 50V
▲C851	4822 122 33276	CERAMIC 0.01 $\mu$ F $\pm$ 20% 400V
▲C853	4822 122 33276	CERAMIC 0.01 $\mu$ F $\pm$ 20% 400V
▲C861	4822 122 33276	CERAMIC 0.01 $\mu$ F $\pm$ 20% 400V
▲C862	4822 122 33276	CERAMIC 0.01 $\mu$ F $\pm$ 20% 400V
<b>PP03-SEMICONDUCTORS</b>		
▲DU54	4822 130 80839	DIODE, S5688G VRM=400V IO=1A
▲DU55	4822 130 80839	DIODE, S5688G VRM=400V IO=1A
▲D801	4822 130 32506	DIODE, RL103E(RECTRON)/DSF10C
▲D812	4822 130 80839	DIODE, S5688G VRM= 400V IO=1A
▲D815	4822 130 80839	DIODE, S5688G VRM= 400V IO=1A
▲D816	4822 130 80839	DIODE, S5688G VRM= 400V IO=1A
▲D820	4822 130 32506	DIODE, RL103E(RECTRON)/DSF10C
▲D821	4822 130 32506	DIODE, RL103E(RECTRON)/DSF10C
<b>PP03-MISCELLANEOUS</b>		
▲F801	4822 253 30414	FUSE, 630MA 250V BS
▲J093	4822 267 31416	JACK, AC INLET
▲L801	4822 146 21699	POWER TRANSFORMER [01]
▲L802	4822 146 21697	POWER TRANSF. [02/05/07]
▲L802	4822 242 72523	EMI NOISE FILTER
▲S851	4822 276 13364	PUSH SWITCH POWER SW TV-3
<b>PP63-POWER TRANSFORMER TERMINAL CIRCUIT BOARD</b>		
<b>PP63-CAPACITORS</b>		
C824	4822 122 40589	CERAMIC 0.047 $\mu$ F $\pm$ 20% 50V
C825	4822 122 40589	CERAMIC 0.047 $\mu$ F $\pm$ 20% 50V
C830	4822 122 40589	CERAMIC 0.022 $\mu$ F $\pm$ 20% 50V
<b>PS03-DC POWER SUPPLY CIRCUIT BOARD</b>		
<b>PS03-CAPACITORS</b>		
C871	4822 122 40589	CERAMIC 0.047 $\mu$ F $\pm$ 20% 50V
C872	4822 124 22238	ELECT 100 $\mu$ F 25V
C873	4822 122 40589	CERAMIC 0.047 $\mu$ F $\pm$ 20% 50V
C874	4822 124 22238	ELECT 100 $\mu$ F 25V
C875	4822 122 40589	CERAMIC 0.047 $\mu$ F $\pm$ 20% 50V
C876	4822 124 41537	ELECT 220 $\mu$ F 6.3V
C877	4822 122 40589	CERAMIC 0.047 $\mu$ F $\pm$ 20% 50V
C878	4822 124 41537	ELECT 220 $\mu$ F 6.3V

REF. DESIG.	PART NO.	DESCRIPTION
<b>PS03-SEMICONDUCTORS</b>		
▲D871	4822 130 80839	DIODE, S5688G VRM=400V IO=1A
▲D873	4822 130 80839	DIODE, S5688G VRM=400V IO=1A
▲Q871	4822 209 31926	IC, PO12RA1 1A+12V
▲Q872	4822 209 73954	IC, NJM7912FA 1A-12V
▲Q873	4822 209 31925	IC, PC05RA11 1A,5V
▲Q874	4822 209 31927	IC, PO05RR1 1A,5V
<b>PW02- HEAD PHONE CIRCUIT BOARD</b>		
<b>PW02-CAPACITORS</b>		
CH31	4822 122 40586	CERAMIC 0.01 $\mu$ F $\pm$ 20%
CH32	4822 122 40586	CERAMIC 0.01 $\mu$ F $\pm$ 20%
CH33	4822 122 40617	CERAMIC 0.1 $\mu$ F +80%-20% 50V
<b>PW02-MISCELLANEOUS</b>		
JH02	4822 267 31611	JACK, HEAD PHONE
LH31	4822 526 10584	FERRITE CORE
LH33		
<b>PW03-READ/WRITE CIRCUIT BOARD</b>		
<b>PW03-CAPACITORS</b>		
C101	4822 126 11687	CERAMIC 0.1 $\mu$ F +80%-20% CHIP
C102	4822 122 32672	TANTLUM 1 $\mu$ F 16V CHIP
C103	4822 124 11334	TANTLUM 4.7 $\mu$ F 16V CHIP
C104	4822 126 11678	CERAMIC 1 $\mu$ F +80%-20% CHIP
C111	4822 124 11074	TANTLUM 10 $\mu$ F 16V CHIP
C113	4822 122 32672	TANTLUM 1 $\mu$ F 16V CHIP
C114	4822 122 32672	TANTLUM 1 $\mu$ F 16V CHIP
C115	4822 122 32677	TANTLUM 2.2 $\mu$ F 6.3V CHIP
C116	4822 122 32677	TANTLUM 2.2 $\mu$ F 6.3V CHIP
C117	4822 126 12501	CERAMIC 1800PF $\pm$ 10% CHIP
C118	4822 126 12501	CERAMIC 1800PF $\pm$ 10% CHIP
C119	4822 124 11074	TANTLUM 10 $\mu$ F 16V CHIP
C121		
C122	4822 126 11565	CERAMIC 0.01 $\mu$ F $\pm$ 10% CHIP
C132		
C133	4822 126 11687	CERAMIC 0.1 $\mu$ F +80%-20% CHIP
C134	4822 126 11687	CERAMIC 0.1 $\mu$ F +80%-20% CHIP
C135	4822 124 11335	TANTLUM 63 $\mu$ F 10V CHIP
C137	4822 124 11335	TANTLUM 68 $\mu$ F 10V CHIP
C138	4822 126 11687	CERAMIC 0.1 $\mu$ F +80%-20% CHIP
C140	4822 124 11335	TANTLUM 63 $\mu$ F 10V CHIP
C141	4822 126 11687	CERAMIC 0.1 $\mu$ F +80%-20% CHIP
C143	4822 124 11334	TANTLUM 4.7 $\mu$ F 16V CHIP
C144	4822 126 11678	CERAMIC 1 $\mu$ F +80%-20% CHIP
C145	4822 126 11678	CERAMIC 1 $\mu$ F +80%-20% CHIP
C150	4822 124 11335	TANTLUM 68 $\mu$ F 10V CHIP
C151	4822 126 11667	CERAMIC 0.1 $\mu$ F +80%-20% CHIP
C152	4822 126 11667	CERAMIC 0.1 $\mu$ F +80%-20% CHIP
C157	4822 126 11663	CERAMIC 3300PF $\pm$ 10% CHIP
C165		
C181	4822 126 11667	CERAMIC 0.1 $\mu$ F +80%-20% CHIP
C185		
C190	4822 126 12503	CERAMIC 0.033 $\mu$ F +80%-20% CHIP
C191	4822 126 12503	CERAMIC 0.033 $\mu$ F +80%-20% CHIP
C192	4822 126 11681	CERAMIC 1000PF $\pm$ 10% CHIP



REF. DESIG.	PART NO.	DESCRIPTION
C193	4822 126 12498	CERAMIC 39PF ±5% CHIP
C194	4822 126 11566	CERAMIC 220PF ±10% CHIP
C195	4822 126 11566	CERAMIC 220PF ±10% CHIP
C196	4822 126 11687	CERAMIC 0.1μF +80%-20% CHIP
<b>PW03-RESISTORS</b>		
R101	4822 100 11943	4.7KΩ ±25% 1/10W, TRIMMING, A BIAS CHIP
R102	4822 100 11943	4.7KΩ ±25% 1/10W, TRIMMING, B BIAS CHIP
R103	4822 051 30473	47KΩ ±5% 1/16W, CHIP
R104	4822 051 30473	47KΩ ±5% 1/16W, CHIP
R105	4822 051 30303	30KΩ ±5% 1/16W, CHIP
R106	4822 051 30303	30KΩ ±5% 1/16W, CHIP
R107	4822 051 30154	150KΩ ±5% 1/16W, CHIP
R108	4822 051 30154	150KΩ ±5% 1/16W, CHIP
R109	4822 100 11943	4.7KΩ ±25% 1/10W, TRIMMING, A BIAS CHIP
R110	4822 100 11943	4.7KΩ ±25% 1/10W, TRIMMING, B BIAS CHIP
R111	4822 051 30109	10Ω ±5% 1/16W, CHIP
R114	4822 051 30561	560Ω ±5% 1/16W, CHIP
R115	4822 051 30561	560Ω ±5% 1/16W, CHIP
R116	4822 116 82487	0Ω, CHIP
R120	4822 051 30682	6.8KΩ ±5% 1/16W, CHIP
R121	4822 051 30682	6.8KΩ ±5% 1/16W, CHIP
R122	4822 051 30104	100KΩ ±5% 1/16W, CHIP
R125	4822 051 30102	1KΩ ±5% 1/16W, CHIP
R126	4822 051 30102	1KΩ ±5% 1/16W, CHIP
R129	4822 051 30479	47Ω ±5% 1/16W, CHIP
R130	4822 051 30471	470Ω ±5% 1/16W, CHIP
R131	4822 051 30331	330Ω ±5% 1/16W, CHIP
R132	4822 051 30561	560Ω ±5% 1/16W, CHIP
R133	4822 116 83221	8.2KΩ ±5% 1/16W, CHIP
R134	4822 116 83208	12KΩ ±5% 1/16W, CHIP
R135	4822 100 11604	1KΩ ±25% 1/10W, TRIMMING, D OUT CHIP
R136	4822 116 83214	39KΩ ±5% 1/16W, CHIP
R137	4822 116 83352	560Ω ±5% 1/10W, CHIP
R145	4822 051 30561	560Ω ±5% 1/16W, CHIP
R151	4822 111 92129	22Ω ±1% 1/4W, CHIP
R155	4822 111 92131	2.2Ω ±5% 1/4W, CHIP
R156	4822 111 92133	180Ω ±5% 1/4W, CHIP
R158	4822 051 30229	22Ω ±5% 1/16W, CHIP
R166	4822 051 30229	22Ω ±5% 1/16W, CHIP
R167	4822 100 11941	100Ω, TRIMMING, I REC. CHIP
R171	4822 051 30472	4.7KΩ ±5% 1/16W, CHIP
R172	4822 051 30472	4.7KΩ ±5% 1/16W, CHIP
R180	4822 051 30102	1KΩ ±5% 1/16W, CHIP
R181	4822 051 30331	330Ω ±5% 1/16W, CHIP
R182	4822 051 30109	10Ω ±5% 1/16W, CHIP
R183	4822 116 83221	8.2KΩ ±5% 1/16W, CHIP
R184	4822 111 91077	56Ω ±5% 1/10W, CHIP
R185	4822 116 83211	1.8KΩ ±5% 1/16W, CHIP
R186	4822 116 83218	68Ω ±5% 1/16W, CHIP
R187	4822 111 92127	40Ω THERMISTOR, CHIP
R192	4822 116 83211	1.8KΩ ±5% 1/16W, CHIP
R193	4822 051 30152	1.5KΩ ±5% 1/10W, CHIP
R194	4822 051 30561	560Ω ±5% 1/16W, CHIP
R195	4822 051 30101	100Ω ±5% 1/16W, CHIP
R196	4822 051 30399	27Ω ±5% 1/16W, CHIP
R197	4822 051 30399	39Ω ±5% 1/16W, CHIP
R198	4822 051 30399	39Ω ±5% 1/16W, CHIP

REF. DESIG.	PART NO.	DESCRIPTION
<b>PW03-SEMICONDUCTORS</b>		
Q101	4822 209 31918	IC, READ AMP TDA1317 CHIP
Q102	4822 130 43398	TRANSISTOR, 2SC2712(G), CHIP
Q103	4822 130 43398	TRANSISTOR, 2SC2712(G), CHIP
Q104	4822 130 43954	TRANSISTOR, 2SD999 (CL,CK), CHIP
Q105	4822 130 42733	TRANSISTOR, 2SA1162-G, CHIP
Q106	4822 130 43398	TRANSISTOR, 2SC2712(G), CHIP
Q151	4822 209 31919	IC,WRITE AMP TDA1316T-N2 CHIP
Q153	4822 130 62522	DIGITAL TRANSISTOR, UN21T 22K CHIP
Q180	4822 130 43398	TRANSISTOR, 2SC2712(G), CHIP
Q181	4822 209 62503	IC, 74HC4053 CHIP
Q182	4822 209 31934	IC, 74HC175 CHIP
Q183	4822 209 31928	IC, CMOS 74HC00 CHIP
Q184	4822 209 31933	IC, 74HC163 CHIP
Q185	4822 209 63341	IC, 74HC02 CHIP
Q190	4822 130 43398	TRANSISTOR, 2SC2712(G), CHIP
<b>PW03-MISCELLANEOUS</b>		
J101	4822 265 31041	JACK, 30P GOLD
J103	4822 265 31037	JACK, 18P CFM
J111	4822 116 83251	CHECKER CHIP
J112	4822 116 83251	CHECKER CHIP
J121	4822 116 83251	CHECKER CHIP
J122	4822 116 83251	CHECKER CHIP
J151	4822 116 83251	CHECKER CHIP
J152	4822 116 83251	CHECKER CHIP
L101	4822 157 70298	CHOKO COIL 15μH ±20% 5MA CHIP
L102	4822 157 70298	CHOKO COIL 15μH ±20% 5MA CHIP
W103	4822 321 61806	JUMPER LEAD, 18P CARD TYPE
<b>PZ03-DIGITAL CIRCUIT BOARD</b>		
<b>PZ03-CAPACITORS</b>		
C401	4822 126 11687	CERAMIC 0.1μF +80%-20% CHIP
C406	4822 126 11687	CERAMIC 0.1μF +80%-20% CHIP
C409	4822 126 11687	CERAMIC 0.1μF +80%-20% CHIP
C410	4822 126 11687	CERAMIC 0.1μF +80%-20% CHIP
C411	4822 126 11655	CERAMIC 0.01μF ±10% CHIP
C412	4822 126 11687	CERAMIC 0.1μF +80%-20% CHIP
C418	4822 126 11668	CERAMIC 220PF ±5% 50V CHIP
C423	4822 124 11074	TANTLUM 10μF 16V CHIP
C424	4822 124 11226	TANTLUM 22μF 6.3V CHIP
C425	4822 126 11687	CERAMIC 0.1μF +80%-20% CHIP
C426	4822 124 11332	TANTLUM 2.2μF 50V CHIP
C427	4822 126 11687	CERAMIC 0.1μF +80%-20% CHIP
C428	4822 126 11687	CERAMIC 0.1μF +80%-20% CHIP
C429	4822 124 11074	TANTLUM 10μF 16V CHIP
C430	4822 126 11687	CERAMIC 0.1μF +80%-20% CHIP
C431	4822 124 11074	TANTLUM 10μF 16V CHIP
C432	4822 122 33777	CERAMIC 47PF ±5% 50V CHIP
C433	4822 126 11687	CERAMIC 0.1μF +80%-20% CHIP
C434	4822 126 11687	CERAMIC 0.1μF +80%-20% CHIP
C440	4822 126 11687	CERAMIC 0.1μF +80%-20% CHIP
C441	4822 126 12504	CERAMIC 0.039μF +80%-20% CHIP
C442	4822 126 12499	CERAMIC 0.47μF +80%-20% CHIP
C443	4822 126 11687	CERAMIC 0.1μF +80%-20% CHIP
C446	4822 124 11074	TANTLUM 10μF 16V CHIP
C448	4822 126 11562	CERAMIC 100PF ±5% 50V CHIP
C449	4822 126 11687	CERAMIC 0.1μF +80%-20% CHIP
C450	4822 124 11074	TANTLUM 10μF 16V CHIP
C451	4822 122 33744	CERAMIC 100PF ±5% 50V CHIP
C453	4822 122 33744	CERAMIC 100PF ±5% 50V CHIP
C457	4822 122 33753	CERAMIC 150PF ±5% 50V CHIP

REF. DESIG.	PART NO.	DESCRIPTION
C471 C474	4822 126 12497	CERAMIC 7PF $\pm 0.5$ PF 50V CHIP
<b>PZ03-RESISTORS</b>		
RJ03 RJ04	4822 116 82487	0 $\Omega$ $\pm 5\%$ 1/16W, CHIP 0 $\Omega$ $\pm 5\%$ 1/16W, CHIP
R402 R411 R413 R417 R418 R423 R428 R429 R430 R432	4822 051 30104 4822 051 30222 4822 116 82487 4822 116 82487 4822 116 83207 4822 051 30272 4822 116 83208 4822 116 92132 4822 111 92133 4822 051 30221	100K $\Omega$ $\pm 5\%$ 1/16W, CHIP 2.2K $\Omega$ $\pm 5\%$ 1/16W, CHIP 0 $\Omega$ $\pm 5\%$ 1/16W, CHIP 0 $\Omega$ $\pm 5\%$ 1/16W, CHIP 1.2K $\Omega$ $\pm 5\%$ 1/16W, CHIP 2.7K $\Omega$ $\pm 5\%$ 1/16W, CHIP 12K $\Omega$ $\pm 5\%$ 1/16W, CHIP 120 $\Omega$ $\pm 5\%$ 1/4W, CHIP 180 $\Omega$ $\pm 5\%$ 1/4W, CHIP 220 $\Omega$ $\pm 5\%$ 1/16W, CHIP
R434 R435 R441 R442 R443 R444 R445 R447 R448 R449	4822 051 30473 4822 051 30473 4822 051 30103 4822 051 30104 4822 051 30222 4822 051 30222 4822 116 83207 4822 051 30104 4822 051 30223 4822 051 30223	47K $\Omega$ $\pm 5\%$ 1/16W, CHIP 47K $\Omega$ $\pm 5\%$ 1/16W, CHIP 10K $\Omega$ $\pm 5\%$ 1/16W, CHIP 100K $\Omega$ $\pm 5\%$ 1/16W, CHIP 2.2K $\Omega$ $\pm 5\%$ 1/16W, CHIP 2.2K $\Omega$ $\pm 5\%$ 1/16W, CHIP 1.2K $\Omega$ $\pm 5\%$ 1/16W, CHIP 100K $\Omega$ $\pm 5\%$ 1/16W, CHIP 22K $\Omega$ $\pm 5\%$ 1/16W, CHIP 22K $\Omega$ $\pm 5\%$ 1/16W, CHIP
R450 R451 R452 R453 R454 R455 R456 R457 R460 R463	4822 051 30103 4822 051 30303 4822 051 30303 4822 051 30472 4822 051 30682 4822 100 11942 4822 051 30102 4822 051 30331 4822 051 30472	10K $\Omega$ $\pm 5\%$ 1/16W, CHIP 30K $\Omega$ $\pm 5\%$ 1/16W, CHIP 30K $\Omega$ $\pm 5\%$ 1/16W, CHIP 4.7K $\Omega$ $\pm 5\%$ 1/16W, CHIP 6.8K $\Omega$ $\pm 5\%$ 1/16W, CHIP 10K $\Omega$ TRIMMING, CHIP 1K $\Omega$ $\pm 5\%$ 1/16W, CHIP 330 $\Omega$ $\pm 5\%$ 1/16W, CHIP 4.7K $\Omega$ $\pm 5\%$ 1/16W, CHIP
R471 R472 R473 R474 R479 R484 R485 R487 R490	4822 051 30105 4822 051 30102 4822 051 30105 4822 051 30102 4822 051 30339 4822 051 30102 4822 051 30339	1M $\Omega$ $\pm 5\%$ 1/16W, CHIP 1K $\Omega$ $\pm 5\%$ 1/16W, CHIP 1M $\Omega$ $\pm 5\%$ 1/16W, CHIP 1K $\Omega$ $\pm 5\%$ 1/16W, CHIP 33 $\Omega$ $\pm 5\%$ 1/16W, CHIP 1K $\Omega$ $\pm 5\%$ 1/16W, CHIP 33 $\Omega$ $\pm 5\%$ 1/16W, CHIP
R491 R498 R499	4822 051 30472 4822 051 30339	4.7K $\Omega$ $\pm 5\%$ 1/16W, CHIP 33 $\Omega$ $\pm 5\%$ 1/16W, CHIP
<b>PZ03-SEMICONDUCTORS</b>		
D421	4822 130 83231	ZENER DIODE, 3.6V 02CZ3.6X CHIP
Q401 Q402 Q403 Q404 Q405 Q406 Q409 Q410 Q411	4822 209 31912 4822 209 31912 4822 209 31913 4822 209 31914 4822 209 31915 4822 209 31921 4822 209 72624 4822 209 31916 4822 130 62522	IC, SBF-L SAA2001 CHIP IC, SBF-R SAA2001 CHIP IC, SBC SAA2021 CHIP IC, DDSP SAA2041 CHIP IC, ERCO SAA2031 CHIP IC, 64K BITX4 D-RAM MB81464 CHIP IC, TC4539BF, $\mu$ PC4539BF CHIP IC, ADAS SAA2011 CHIP DIGITAL TRANSISTOR, UN2217 22K CHIP
Q412	4822 209 31929	IC, 74HC32 CHIP
Q421 Q422	4822 130 43398 4822 130 42733	TRANSISTOR, 2SC2712(G), CHIP TRANSISTOR, 2SA1162(G), CHIP

REF. DESIG.	PART NO.	DESCRIPTION
Q423 Q441 Q442 Q443 Q444	4822 209 31917 4822 209 31922 4822 209 61534 4822 209 31909 4822 209 31931	IC, DEQ2 SAA2051 CHIP IC, DAI M51581FD CHIP IC, CMOS 74HCU04 CHIP IC, NES230D CHIP IC, 74HC4046 CHIP
<b>PZ03-MISCELLANEOUS</b>		
J408 J409 J441 J442	4822 265 31038 4822 116 83251 4822 265 31039 4822 116 83251	JACK CHECKER CHIP (RD-MUX) CHECKER CHIP (VCO-CONTROL) CHECKER CHIP (RXCK)
L421 L441	4822 157 53873 4822 157 53873	CHOKE COIL 100 $\mu$ H $\pm 10\%$ 40MA CHIP CHOKE COIL 100 $\mu$ H $\pm 10\%$ 40MA CHIP
X401 X402	4822 242 81345 4822 242 81344	CRYSTAL, 24.526MHZ CHIP CRYSTAL, 22.5792MHZ CHIP

**NOTE ON SAFETY:**

Symbol  $\blacktriangle$  Fire or electrical shock hazard. Only original parts should be used to replace any part marked with symbol  $\blacktriangle$ . Any other component substitution (other than original type), may increase risk of fire or electrical shock hazard.